



CLASSROOM & TECHNOLOGY DESIGN & CONSTRUCTION MINIMUM REQUIREMENTS

PREPARED BY
PLANNING | DESIGN | PROPERTIES

IN
COLLABORATION
WITH

MEMBERS OF
LEARNING SPACE LEADERSHIP COMMITTEE
OPERATION & TECHNOLOGY SUBCOMMITTEE
&
OPP PERSONNEL

3/19/2020

INDEX FOR

CLASSROOM & TECHNOLOGY DESIGN & CONSTRUCTION MINIMUM REQUIREMENTS

DIVISION 00.30.00 INTRODUCTION / GENERAL INFORMATION..... 1

00.30.01 WHY IS THERE THIS MINIMUM REQUIREMENT DOCUMENT FOR PSU CLASSROOMS: 1

00.31.00 MINIMAL CONSIDERATIONS:..... 1

00.31.01 GENERAL PURPOSE CLASSROOMS:..... 1

00.32.01 COLLEGE AND/OR DEPARTMENTAL CLASSROOMS, SEMINAR ROOMS AND LECTURE HALLS:..... 2

00.33.00 TRENDS:..... 2

00.34.00 LEARNING SPACE LEADERSHIP COMMITTEE (LSLC):..... 2

00.34.01 LSLC – OPERATION & TECHNOLOGY SUBCOMMITTEE: 3

00.35.00 ABBREVIATIONS USED:..... 4

DIVISION 01.40.00 QUALITY REQUIREMENTS4

01.41.01 BACKGROUND AND BUILDING NOISES AT OR NEAR CLASSROOMS:..... 4

01.41.02 COMMISSIONING AT CLASSROOMS:..... 5

01.42.00 GENERALIZED CLASSROOM DESIGN CONSIDERATIONS:..... 5

01.42.01 GENERAL BUILDING DESIGN CONSIDERATIONS RELATED TO GENERAL PURPOSE CLASSROOMS:..... 5

01.42.02 CORRIDORS & SEATING OUTSIDE CLASSROOMS:..... 5

01.42.03 STUDENT WAITING / MEETING ALCOVES / COMMONS:..... 6

01.42.04 CLASSROOM DESIGN:..... 6

01.42.05 ROOM DIMENSIONAL RATIOS: 7

01.43.00 CODES, ADA, ACCEPTED STANDARDS, CONTROLLING AUTHORITY AND AGENCY REQUIREMENTS: 7

01.44.00 VISUAL:..... 7

01.45.00 CLASSROOM EQUIPMENT STORAGE:..... 7

DIVISION 02.00.00 GENERAL REQUIREMENTS.....8

02.60.00 ASBESTOS:..... 8

DIVISION 05.00.00 METALS 8

05.00.01 REFERENCES:..... 8

DIVISION 08.00.00 OPENINGS.....8

08.10.00 DOORS:..... 8

08.50.00 WINDOWS, CLERESTORIES, SKYLIGHTS: 8

08.70.00	HARDWARE (DOORS):	9
<u>DIVISION 09.00.00 FINISHES</u>		9
09.00.01	GENERAL – APPLYING TO ALL CLASSROOM WALLS, FLOORS AND CEILINGS:	9
09.20.00	WALLS:	10
09.50.00	CEILINGS:	10
09.50.01	CEILINGS - HEIGHTS:	10
09.50.02	CEILINGS – SPECIAL REQUIREMENTS:	11
09.60.00	CLASSROOM FLOORS:	11
<u>DIVISION 10.00.00 SPECIALTIES</u>		12
10.11.00	CHALK AND TACK BOARDS:	12
10.14.00	ROOM SIGNS:	14
<u>DIVISION 11.00.00 EQUIPMENT</u>		15
11.52.00	PROJECTION SCREENS:	15
<u>DIVISION 12.00.00 FURNISHINGS</u>		17
12.20.00	WINDOW & WINDOW COVERINGS:	17
12.50.00	FURNISHINGS – SPECIAL EQUIPMENT:	17
12.50.01	STUDENT SEATING - GENERAL:	17
12.50.02	STUDENT SEATING – SQUARE FOOTAGE REQUIREMENTS FOR SEATING TYPE:	18
12.50.03	STUDENT SEATING – STUDENT SEATING SPACE PLANNING PARAMETERS:	18
12.50.04	STUDENT SEATING - LABELING:	20
12.51.00	STUDENT SEATING - TYPES:	20
12.51.05	INSTRUCTIONAL AND STUDENT LABORATORY TECHNOLOGY SEATING STATIONS:	22
12.51.06	INSTRUCTOR TABLE:	22
12.51.07	INSTRUCTOR STOOL AT INSTRUCTIONAL TECHNOLOGY PODIUM:	22
12.51.09	COAT HANGING RACKS / STRIPS:	23
12.51.10	TRASH AND RECYCLING CONTAINERS:	23
12.51.11	CART MOUNTED OVERHEAD PROJECTORS:	23
<u>DIVISION 20.00.00 PLUMBING, HVAC, FIRE SPRINKLING SYSTEMS, ETC.</u>		23
20.01.00	NOISES, VIBRATIONS & VISUAL CONSIDERATIONS FROM PLUMBING, SPRINKLING & HVAC:	24
20.01.01	PIPES:	24
20.01.02	HVAC AND AIR MOVEMENT:	24

<u>20.01.03 PIPING, DUCTS AND BUILDING EQUIPMENT INTERFERENCES WITH GPC EQUIPMENT:</u>	25
<u>20.01.04 BUILDING MECHANICAL AND MACHINERY NOISES AND VIBRATIONS:</u>	25
<u>20.01.05 THERMOSTATS:</u>	25
<u>20.01.06 FIRE STROBE LIGHTS:</u>	25
<u>20.01.07 COMMISSIONING OF CLASSROOMS:</u>	25
<u>DIVISION 26.00.00 ELECTRICAL</u>	26
<u>26.05.00 CONDUITS, WIREWAYS, LOW VOLTAGE WIRES, OTHER WIRES, WIREMOLD & OTHER UTILITY LINES:</u> ..	26
<u>DIVISION 26.50.00 CLASSROOM LIGHTS AND LIGHTING CONTROLS</u>	27
<u>26.51.00 CLASSROOM LIGHTS AND LIGHTING CONTROL – GENERAL:</u>	27
<u>26.52.00 LIGHTING – DEVICE PLATES AND SWITCHES:</u>	28
<u>26.53.00 LIGHTING – MOTION & ULTRASONIC/SOUND SENSORS:</u>	28
<u>26.54.00 GENERAL ROOM LIGHTING:</u>	28
<u>26.54.01 LIGHT SWITCH CONTROL LOCATIONS AND TYPE:</u>	28
<u>26.54.02 SWITCH CONTROL ENGRAVING AND RELATIVE POSITIONS:</u>	29
<u>26.54.03 GENERAL ROOM LIGHTING ZONES:</u>	29
<u>26.54.04 CHALK BOARD LIGHTING ZONES:</u>	30
<u>26.54.05 INSTRUCTIONAL PODIUM AND SIGNER LIGHTING ZONES:</u>	30
<u>26.54.06 INSTRUCTIONAL TABLE LIGHTING ZONES:</u>	31
<u>26.55.00 CLASSROOM EMERGENCY LIGHTS:</u>	31
<u>26.56.00 CLASSROOM EMERGENCY EXIT LIGHT SIGNS:</u>	31
<u>26.57.00 CORRIDOR AND STUDY COMMONS LIGHTING:</u>	31
<u>26.60.00 SWITCH & DEVICE PLATE LAYOUTS & LOCATIONS ON WALLS:</u>	32
<u>26.70.00 CONVENIENCE & DUPLEX OUTLETS:</u>	32
<u>DIVISION 27.00.00 COMMUNICATIONS</u>	33
<u>27.00.00 GENERAL:</u>	33
<u>27.30.00 TELEPHONES:</u>	34
<u>27.31.00 WIRELESS COMPUTER SYSTEMS:</u>	34
<u>27.32.00 INTERACTIVE VIDEO CONFERENCING SYSTEMS:</u>	34
<u>27.33.00 INSTRUCTIONAL TECH CABLING:</u>	35
<u>27.40.00 SOUND SYSTEM:</u>	35
<u>27.41.00 AUDIO-VISUAL and TECHNOLOGY:</u>	35
<u>27.41.01 TECHNOLOGY EQUIPMENT “CLOSET”:</u>	35

27.41.02 POWER AND CONTROLS: 35

27.41.03 CEILING HUNG DATA PROJECTOR: 36

27.41.04 CONVENTIONAL AV POWER / CONDUIT NEEDS: 37

27.41.05 TECHNOLOGY OUTLETS / POWER / CONDUIT NEEDS: 37

27.41.06 INSTRUCTIONAL TECH PODIUM: 39

27.41.07 COMPUTER LAB - CLASSROOM: 39

27.41.07 d COMPUTER LAB – CLASSROOM – Who does what: 40

27.41.08 AMX, CRESTRON OR OTHER SPECIAL MEDIA & TECHNOLOGY CONTROL SYSTEMS: 41

27.41.09 HEAD END (BUILDING TECHNOLOGY CONTROL) ROOMS (HER): 42

DIVISION 28.00.00 ELECTRONIC SAFETY AND SECURITY 42

28.00.00 GENERAL: 42

28.01.00 SECURITY LINES: 43

28.01.02 REFERENCES: 43

28.10.00 BUILDING SECURITY (DOORS): 43

28.20.00 CORRIDOR SECURITY CAMERAS: 43

28.41.00 CLASSROOM TECH EQUIPMENT SECURITY – GENERAL: 43

28.42.01 GPC AND GPC – COMPUTER LABS: 44

28.42.02 TERMINATION DEVICES TO BE NOTED & LOCATIONS DEFINED FOR EACH PARTICULAR GPC: 44

28.42.03 WHO PROVIDES AND DOES WHAT: 44

DIVISION 40.80.00 COMMISSIONING 45

40.81.00 GENERAL: 45

40.81.00 ARCHITECTURAL: 45

40.82.00 STRUCTURAL: 46

40.83.00 PLUMBING, SPRINKLING SYSTEMS & HVAC: 46

40.84.00 ELECTRICAL, LIGHTING & TELECOMMUNICATIONS: 46

40.85.00 ELECTRONIC SAFETY AND SECURITY: 46

END 46

DIVISION 00.30.00 INTRODUCTION / GENERAL INFORMATION:

00.30.01 Why is there this Minimum Requirements Document for PSU Classrooms:

- a. To help minimize recurring design and construction problems that negatively impact classrooms;
- b. To help eliminate incongruities in classrooms, especially related to use of the various switches, labeling, and other controls;
- c. To document those classroom aspects very critical to supporting the room users and identify those parts that can negatively affect the room;
- d. To define distractions that can hinder the learning and instructional process so that the distractions are eliminated or at least minimized;
- e. To minimize “redo” change orders and help save on project cost;
- f. To help each project and all design team members by being a communicating tool with those having operational and day to day responsibilities of the PSU classrooms.

00.31.00 Minimal Considerations:

- a. The information presented in this document deserves minimal considerations for the design and construction of all PSU **classrooms, seminar rooms and lecture halls** being designed or planned new or in remodeled work.
- b. Please note that this is a “living” document that is periodically updated as new needs are introduced to the ever evolving educational environment. Due to this evolutionary need, the design team may be introduced to some of the newer and very important developments not yet identified in this document. Such changes need to be carefully considered and incorporated into the design and construction process when presented to the leadership involved with the project.
- c. The intent of this document is to NOT impede progressive thinking relative to classroom design. However, the information is presented to indicate the minimum and sometimes maximum requirements necessary when this document was last updated. New ideas that can be conducive to the educational process are encouraged and are to be presented to the **LSLC-Operation & Technology Subcommittee** for evaluation and feedback to the design team, should the new idea either have merit or not appear appropriate for the particular circumstances. Such communication should be in writing.

00.31.01 General Purpose Classrooms (GPCs):

GPCs are defined as those classrooms, classroom/computer labs, seminar rooms and lecture halls that are scheduled via the Registrar’s Office for use by PSU faculty, staff, colleges, departments or PSU organizations. To allow easy use across the campus by all instructors, all **GPCs** by necessity require common elements.

00.31.02 GPCs are monitored and maintained by representatives from the Office of Physical Plant (janitors, area services, maintenance personnel, etc) and the **Learning Space Leadership Committee (LSLC) Operations & Technology Subcommittee**, composed of members from various disciplines. The **GPCs** are up-graded by OPP or are created new as part of a new building and need to have involved the disciplines representing the above Committee.

00.31.03 Additional considerations are often addressed and included in the **GPCs** that may be specific to the localized needs of a college or department, while including these **Classroom and Technology Design and Construction Minimum Requirements** hereafter referred to as **GPC Minimum**

Requirements. Such additional considerations in **GPCs** are the responsibility of the college or department to pay for, maintain and upgrade.

/

00.32.01 College and/or departmental labs:

(CDLs) - The recommendation is that **ALL CDLs** comply with these **GPC Minimum Requirements**. At the very least, do not design and build labs, seminar rooms that inhibit the later upgrade of the **CDLs** to **GPCs**. Additional components may be added to **CDLs** that address the specific needs of the college or department as qualified above.

00.32.02 **CDLs** are defined as those instructional spaces generally maintained and upgraded at the expense of the college or department. During late design, construction or shortly after a project is completed, many colleges or departments decide to have rooms originally defined as **CDLs** converted to **GPCs** – usually due to financial issues. Conversion from **CDLs** to **GPCs** is relatively simple when constructed according to the **GPC Minimum Requirements**. The proper infrastructure and components would be in place. Thus, the college or department would not have to pay to upgrade the **CDLs** to the minimum requirements of the **GPCs**, in order for the classroom to become a **GPC**.

00.33.00 Trends:

00.33.01 Trends are for more and more sophisticated technology in the learning environment. The infrastructure needs to be provided, even if not immediately used or activated.

00.33.02 Note that very often the technical design and construction documents are incomplete. They do not include enough background information identifying expected performance characteristics of the spaces or systems. Please include such commentaries on construction documents.

00.33.03 The most current version of these minimum requirements is available for viewing on the Web at:

<https://wikispaces.psu.edu/display/OPPDCS/01+05+00+GENERAL+PROJECT+REQUIREMENTS>

00.33.04 Other web sites that may be helpful:

<http://lat.tlt.psu.edu/>
http://www.registrar.psu.edu/staff/instructional_facilities/instructional_facilities_inst.cfm

00.33.05 Members of the LSLC-O&T subcom are available to help with any of your classroom needs. See list of names on next page.

00.34.00 Learning Space Leadership Committee (LSLC):

The LSLC is a group of 9 individuals that take responsibility of the instructional spaces at Penn State. There are (3) co-chair positions one is from the Office of the Vice-President and Dean for Undergraduate Education at Penn State. Second is from the Office of Schreyer Institute for Teaching Excellence and Dean for Undergraduate Education, third is from the Office of Teaching and Learning with Technology. The LSLC has members that represent professors, students, the Registrar's Office, Media Tech and Support Services, OPP, the Commonwealth Campuses, Information Technology Services, Teaching & Learning Technology, Educational Equity for Underrepresented Groups and the Schreyer Center.

00.34.01 The LSLC-Operations & Technology Subcommittee LSLC-O&T Sub-com):

The **LSLS-O&T Subcommittee** is a working and detail committee that reports to the **LSLC**. The Learning Spaces Leadership Committee - Operations & Technology Subcommittee members are:

Thomas Kase	Chair – LSLC-O&T Subcommittee Architect, Planning, Design & Properties/OPP	814-865-1598	<tpk11@psu.edu>
Lori Weaver	Co-Chair – LSLC-O&T Subcommittee Manager of Learning Spaces/TLT	814-865-7022	<lmm53@psu.edu>
Blake Bergey	Manager of Classroom and Lab Computing/TLT	814-867-2684	<bab422@psu.edu>
David Bagley	Department Head of Media & Technology Support Services	814-863-0665	<dpb5@psu.edu>
David Test	Manager of Classroom and Lab Technologies/TLT	814-441-9384	<dmt155@psu.edu>
John Hoh	Senior Director of IT – Commonwealth Campuses	717-948-6188	<jdh30@psu.edu>
Matt Leah	OPP – Project Manager	814-360-4235	<mjl289@psu.edu>
Francesca Zola	Student Advocacy Specialist – Office of Disability Resources	814-863-1807	<fmz101@psu.edu>
Tryphena Miska	Registrar Office – Assistant Registrar - Enrollment Services	814-865-7775	<tma140@psu.edu>
Mike Weaver	LSLC-O&T GPC Facilities Coordinator/OPP – PDP	814-865-1599	<mlw38@psu.edu>
To Be Named	Police Services	814-000-0000	<?????@psu.edu>

- a. The **LSLC-O&T subcom** realizes that the design process is most dynamic and that continuing innovations can and should be weighed against the information included in this document. If conflicts from new innovations do occur, all such parameters are to be noted in writing to the **LSLC-O&T-FC** for the **LSLC-O&T** to consider. The **LSLC-O&T** will then make recommendations to the **LSLC** for review, comment and acceptance or rejection and submit the response in writing or email form.
- b. **CONFLICTS:** If conflicts are found between these and other University design and construction requirements, please note the locations within the documents and the conflicts, so that the problem areas can be properly addressed and hopefully eliminated in the next update to this **GPC Minimum Requirements** document.

00.35.00 Abbreviations Used:

ADA	Americans with Disabilities Act
AFF	above finished floor
ALC	Active Learning Classroom
ASHRAE	American Society of Heating, Refrigerating and Air-Conditioning Engineers

CDL(s)	College and department lab(s)
CD	Compact Disk
CRI	Color Rendering Index
DVD	Digital Video Disk
FC	Facilities Coordinator
FR&P	Facilities Resources & Planning
GPC(s)	General Purpose Classroom(s), seminar rooms(s) and lecture hall(s)
>	greater than
HER	Head end room (for technology that routes data to different rooms in a building)
HVAC	Heating, ventilating and air conditioning
IIC	Impact Isolation Class
ITS	Information & Technology Services
LSLC	Learning Spaces Leadership Committee
LSLC-Acad	LSLC – Academic Subcommittee
LSLC-O&T	LSLC – Operations & Technology Subcommittee
<	less than
MTSS	Media Technology and Support Services
NRC	Noise Reduction Coefficient
OPP	Office of Physical Plant
PC	Project Coordinator
PM	Project Manager
SSTs	Stacking Student Tables
STC	Sound Transmission Coefficient
TLT	Teaching and Learning with Technology
TNS	Telecommunications & Networking Services
TV	Television
VCR	Video player

DIVISION 01.40.00 QUALITY REQUIREMENTS

01.41.01 ACOUSTICS AND BACKGROUND NOISES AT OR NEAR GPCs:

Room Acoustics – To be designed for speech with reverb decay of less than:

- a. 0.6 seconds at the mid-speech frequencies of 250, 500 & 1,000 Hertz for room sizes up to 10,000 cubic feet.
- b. 0.7 seconds for same range for rooms up to 20,000 cubic feet.
- c. See following sections for NRC, IIC, NC, etc.
- d. Refer to ANSI/ASA S-12.60, “American National Standard Acoustical Performance Criteria, Design Requirements, and Guidelines for Schools” for additional minimal acoustical considerations that apply to the GPCs. Note that this classroom requirement document has more stringent requirements in some cases.
- e. Partitions should be designed with an STC-50 sound transmission coefficient.

01.41.02 COMMISSIONING AT CLASSROOMS – refer to section 40.80.00.

01.42.00 GENERALIZED CLASSROOM DESIGN CONSIDERATIONS:

01.42.01 General Building Design Considerations Related to General Purpose Classrooms:

- a. Locations for GPCs (new construction and if possible in renovations):
 - (1) Preferably on ground entry level and as close to main traffic entry doors as possible due to high traffic volume.
 - (2) Near major stairs and elevators on levels immediately above and below ground level to isolate class change noise and high traffic functions from office and lab functions.
 - (3) Keep away from noise generating sources as restrooms, building system rooms, labs and hazardous material rooms.
- b. Provide long walk-off mat space (at least four full steps) from exterior doors to first classroom doors to trap dirt, mud, salt, snow, moisture, etc.

01.42.02 Corridors & Seating Outside Classrooms:



- a. Corridors - size for 2-times the loads and 2-times the minimum widths per codes due to the heavy number of students leaving classrooms competing with those trying to get in classrooms, as well as those waiting or talking.
- b. Width - In any case corridors outside GPCs to not be less than 10' wide.
- c. Seating - bench or other type seating is to be provided outside classrooms. Provide the total length of the corridor. Both sides are preferred. Otherwise, alternate from side to side or run continuous on one side, except at doors. Integrate waste receptacles and ADA positions into bench seating.
- d. Power – provide a duplex/USB outlet in the face of the benches spaced about every 3' on center for students to plug in their electronic devices.
- e. Furniture in these spaces should not have fabric or material that would easily be stained. Material considered for this such as vinyl should be easily cleaned but still hold up for heavy usage. All furniture should also be considered for cleaning, codes, maintenance and comfort.

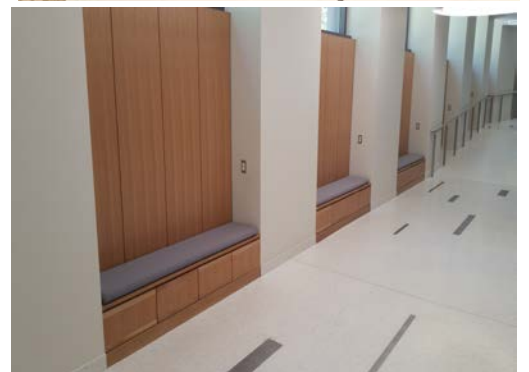

01.42.03 Informal Learning Spaces:

- a. Building programs are encouraged to include these spaces along circulation paths serving classrooms, to allow groups and instructor and students to meet and have discussions between classes or while waiting for classes.
- b. Such spaces can be equipped with markerboards and/or large screen monitors to facilitate student discussions and interactions.



01.42.04 GPC Classroom design – shall be dictated from the educational needs and include the following:

- a. Optimum sight lines achieved.
- b. Sufficient seating arrangements clearances.
- c. Appropriate technology needs for spaces.
- d. Adequate instructional area can be included:
 - (1) To have all areas and writing surfaces easily visible from all student seating.
 - (2) To have one to two 24" x 60" instructor table w/ modesty panel, with chair(s) at table(s).
 - (3) To have minimum 9' space with 11' preferable (as further restricted by screen viewing needs identified later) from board wall to first row of student seats.
 - (4) To have all lighting, screen, tech controls and telephones easily accessible from a defined wall area near any instructional technology lectern (podium).
 - (5) To have (2) ceiling mounted data projectors and (2) projection screens.

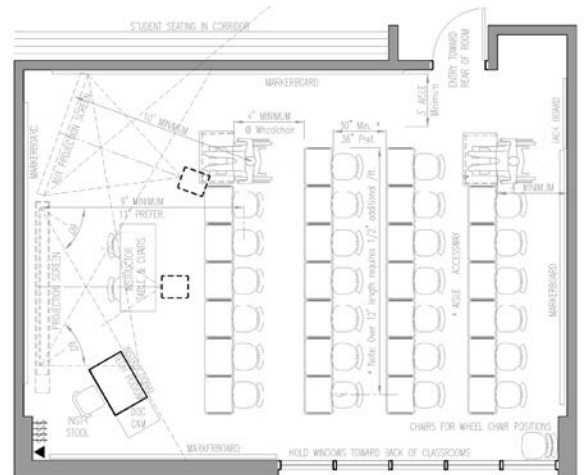

01.42.05 ALC Classroom Design – should be dictated by type of active learning to be executed in this space and be as flexible as possible to permit multiple teaching methods:

- a. The types of ALC's that maybe considered include the following:
 - (1) 6 or 9 person tables for assignment of group work with access to sufficient writing surface which may also have multiple projection or screens at each workgroup.
 - (2) Tiered lecture room with (2) tables per tier to permit students turning to table behind to collaborate in groups:

01.42.06 Room Dimensional ratios:

- a. For rectangular rooms – width to length – between 1-1/2 to 2 and 3 to 4 with the instructional end on the narrower dimension.
- b. Room shape greatly impacts space efficiencies for a particular classroom need – carefully consider and do not use a cookie cutter approach.
- c. For auditorium/lecture rooms – more fan-shaped with seating, screen and instructional needs dictating the shape. Involve **LSLC-O&T** early relative to such spaces for detail needs. Plan early to do floor and furniture plans, as well as cross sectional drawings for discussions with the **LSLC Learning Space Leadership Committee** – Operations & Technology Subcommittee

01.43.00 Codes, ADA, accepted standards, controlling authority and agency requirements:

- a. Comply with or exceed on all new and renovation work.
- b. Understand that PSU requirements in some cases exceed these minimums, thus enhancing the code, ADA, accepted standards, authority and agency requirements. Comply with the PSU enhancements when more stringent. See [Design & Construction Standards](#)
- c. Provide clear and easily accessible paths and means to and from the exterior building doors to and from the classrooms – go only through rooms or spaces dedicated to circulation and waiting.
- d. Provide easily accessible restrooms along paths of travel from building exterior doors to classrooms. See [PSU Access Enhancement](#) and [PSU Signage Standards](#)

01.44.00 Visual:

- a. All student seats to be within side-to-side cone established with 60-degree angles from screen edges in room and the 30-degree vertical angle defined from the eyes of the closest student viewer to the top of the screen and a horizontal line parallel to the floor that extends through the eyes.
- b. Seats to be no closer than the screen height x 1.73. Bottom of image to be minimum 36" AFF, 42" preferred.
- c. No visual obstructions, like columns or podiums, between student seating areas and chalkboards and screens at instructional end of room.
- d. **Glare (on chalkboards, projection surfaces, or whiteboards):**
 - (1) Glare from overhead lighting or data technology projectors cause distractions to learning.
 - (2) The contrast ratio for the student viewing area of the front of the room shall not exceed 3 to 1.

- (3) A light meter is to be used to check this in new and renovated construction in a three-row three-column matrix at the front, with contrasts recorded and noted for correction.
- (4) See requirements for higher lighting fixtures to reduce this problem.

01.45.00 Classroom Equipment Storage:

- a. Space (closet type alcove) to be provided outside a classroom or groups of classrooms for storage of classroom media equipment, such as projection stands, carts, etc.
- b. In classrooms also doubling as computer lab/classrooms, additional space shall be provided for printing tables and lockable storage space for printing supplies, batteries, paper, cartridges, paper waste containers, etc.

DIVISION 02.00.00 GENERAL REQUIREMENTS:**02.60.00. ASBESTOS:**

- 02.60.01** Asbestos may be encountered in renovation projects.
- 02.60.02** Identify early in design process in the room and at other external locations critical to the project area.
- 02.60.03** Identify piping and conduit routes early during design and place outside the classroom spaces being built or remodeled. This requirement is to assist in the detailed planning, design and construction needs as they relate to the GPCs.
- 02.60.04** Contact: Mike Burke at Environmental Health & Safety (814)865-6391 burke@ehs.psu.edu.

DIVISION 05.00.00 METALS:**05.00.00. REFERENCES:**

- 05.00.01** See **27.41.03** – for Unistrut, anchors and all thread rods used for supporting ceiling hung data projectors.

DIVISION 08.00.00 OPENINGS:**08.10.00 DOORS:****08.10.01 Classroom Entry/exit Door Locations:**

- a. For single doors - at rear sides or back of rooms.
- b. For more than one door – preferred in back of room if configuration allows; if not, greater than 8' back from the instructional wall for one of the doors, with the other at the rear sides or back of a room.

08.10.02 General to All Classroom Doors:

- a. Use glass in tall & narrow vision panels allowing wheel chair users to see in and out as well as tall individuals.

- b. Each door leaf to be minimum 36" wide, including those used in pairs at double doors – no strike mullions on double doors.

08.50.00 WINDOWS, CLERESTORIES, SKYLIGHTS:

08.50.01 General to all exterior openings allowing light into classrooms:

1. To have STC capabilities of > 50.
2. To be arranged and designed to not cast sun or day-light onto projected surfaces or chalkboards at the front instructional area, including reflecting light.
3. To be energy efficient double or triple glazed units with e-glass to minimize heat loss or gain.
4. To be located near rear sides of rooms, since markerboards could be on front and side walls.
5. To not be located within 15' of front walls, again to prevent light spill on screens and markerboards.
6. In classrooms heavily equipped with technology components such as scale-up or interactive video conferencing classrooms or distant education classrooms.

08.50.02 Operable windows - Are to have key locks mastered alike for a building, to allow staff to open in case of HVAC failure or as required to achieve LEED points.

08.50.03 Window Coverings – defined in **12.20.00 WINDOW TREATMENT** below.

08.70.00 HARDWARE (DOOR):

- a. To comply with PSU and code requirements with "CR" key lock cores.
- b. To have totally quiet operational and closing characteristics. Minimize noise transmission into classroom from corridors – no door transfer grills.
- c. To have only key lock and unlock **CLASSROOM FUNCTION** assemblies – no pushbuttons in edge plate, no dogging buttons or knobs on panic hardware, must always be able to egress from the classroom side.
- d. To have drop sill plates and edge sound treatment where high noise levels may occur outside of the door (some classes run two periods so should not be disturbed by class changes).
- e. To have bumpers, gaskets, sound strips, nylon bushings, silencers or sound strips on the strike jambs and hardware to minimize closing and impact noises and noises outside the door.
- f. To have minimum 14" high kick plates on both sides of each door.
- g. **Special Door Hardware** – doors to projection booths, media technology rooms and media technology closets – use five push-button re-settable combination locksets (combination is changed each year; no power required in or to units) with "MTSS" key lock core.
- h. **Special Entry Devices for ADA access** – on rooms with more than 50 student seats, the special ADA push plates may be required on each side of one of the accessible doors into the room.
- i. To have door closers on all corridor doors per OPP [Design and Construction Standards – Division 08 70 00.B.2.](#)

- j. Double doors having panic hardware shall have cylinder “dogging” to permit quiet push/pull operation where permitted by code.

DIVISION 09.00.00 FINISHES:

09.00.01 GENERAL – applying to all classroom walls, floors and ceilings:

- a. STC = or > 50
- b. All openings, cracks, joints to be caulked to minimize sound transmission.
- c. Pipe, conduit, duct, cable tray penetrations to be totally stuffed with sound batt or fire safing (where required by codes) with both sides of wall covered by minimum 5/8” thick drywall.

09.20.00 WALLS:

09.20.01 Inside:

- a. All walls surrounding rooms to run tight to structural surfaces and elements above ceilings.
- b. Corridor walls to have double studs staggered to isolate inside and outside wall elements.
- c. All to have non-cellulose sound blankets.

09.20.02 Exterior walls common with classroom:

- a. All penetrations and wall elements to be sealed and designed to minimize noise entry into room.

09.20.03 Finishes:

- a. Apply paint on most surfaces (other than pre-finished wood, stone or masonry surfaces) – no vinyl wall coverings.
- b. Use epoxy/scrub able paints for low wall areas subject to abuse, such as below chair rails and chalkboards.
- c. Apply chair rails on all non-masonry back and side walls in GPCs with movable student furniture. Use “Acrovyn” 6” high x .040” sheets.
- d. Corner Guards – outside wall corners (such as entry recesses to classrooms) – provide stainless steel or aluminum corner guards to 4’ AFF applied so that students cannot work them loose. Include at outside corners where chairs and instructor stools may damage the edges, such as at chase walls or columns.
- e. Accent and multiple colors on walls are desirable – place on walls that will not reflect onto projection screen surfaces. Coordinate color selection and location with lighting designer so that light levels are acceptable and not absorbed or reduced by a dark accent wall.

09.50.00 CEILINGS:

09.50.01 Heights:

- a. **Renovation & Remodels** – keep the finished ceiling as high between screens and ceiling mounted projectors as possible to complement screen viewing, though no less than 9’-6” AFF for small rooms (less than 20 students) with Instructional Technology.

b. **New Construction – clear height at instructional end of room:**

1. Up to 75 students – 11' minimum clear height AFF between tech projector and screens.
2. 75 to 150 students – greater than 13' AFF
3. 150 & over students. – greater than 15' AFF

09.50.02 Special Requirements:

- a. **Screen cases or housings** – ceiling systems to NOT fasten to recessed screen units – units need to be dropped for servicing and replacing worn parts – screens to be placed in recessed box.
- b. **Sight lines** – between screens and any student seating to not be obstructed.
- c. **Obstructions** - keep any ducts and piping along side-walls to avoid recessed screen housings and so area between screens and ceiling mounted projectors is as high as possible.
- d. **Ceiling Materials:**
 1. Use non-sagging (humidity resistant) lay-in acoustical tile for most classroom ceiling areas to allow easy overhead access.
 2. Use tegular tiles & 24 x 24 or 24 x 48 sizes and normal grid members (not narrow designs or metal edged tiles).

09.60.00 CLASSROOM FLOORS:

09.60.01 Multiple floor levels in a GPC – no longer desired are instructional stages, platforms or seating tiers accessed by steps or risers – the needs of ADA access and pathways must be addressed. Only seating tiers are allowed in classrooms with 100 or more student seats, as long as accessible positions are located at the front, back and middle of the room and visual sight lines are maintained between student positions, instructor and screens.

- a. **Color contrasts:**
 1. If occurring at student seating, all aisle riser nosings must be of contrasting color to the remaining flooring colors.
- b. Aisle riser nosings to be metal only – plastic and vinyl do not last in high traffic areas like GPCs. Product Example: American Floor Products G-505R, Item #ST-2500, Style G-500R with contrasting nose color.
- c. Stair nose lighting may be desirable to help identify the steps. An example of such a product is the FL201 aluminum nosing by Nexxus Lighting, Inc., with LED lighting integral to the nosing. An example of the installation is adjacent to this paragraph.
- d. Alternatively, recessed spot lighting to light steps maybe used.

09.60.02 Sloping floors – under auditorium seating and/or at sloped aisles with flat tiers under seating are acceptable.

09.60.03 Ergonomics – sight lines relative to floors with differing elevations – consideration must be given to sight lines between instructors and students so that eye contact is possible between instructor and all students in all situations – for instructors as tall as 6'-8" or as short as 4'-10", as well as those in wheel chairs.

- 09.60.04 Noise** – floor and other elements surrounding classrooms to have an Impact Isolation Class (IIC) that prevents sound transmission into room from floors or equipment surrounding the classrooms. Refer to ANSI/ASA S12.60 for minimal requirements.
- 09.60.05 Flooring** - as identified in project scope or program.
- Use carpet tiles in classrooms, equal or greater than 10 stitches per inch; Antron 6.6 fiber nylon, yarn weight of 20 to 30 ounces; multi-dark colors to not show spills; stain, moisture & wear resistant; impervious and thick Unibond type backing material not affected by moisture; edge curl resistant with no edge ravel; glue resistant to wet cleaning, anti-static, UL Class A.
 - Use only carpet squares pre-glued (preferred) w/ temporary backing to protect glue until carpet in place, where possible, but if not pre-glued full adhesive coverage to be provided.
 - Other special flooring usage requires ISG acceptances, examples vinyl tile or sheet goods – if accepted, use the thickest materials.
 - Submit samples of 18" x 18" minimum sized carpet to be used for stain tests by LSLC-O&T-Subcom.
 - Vinyl carpet edging is not stable – it shrinks. Acclimate in room out of cartons for several weeks prior to installation. When installing the edging do not pull on it, but compress its length as much as possible during the installation process. Examples of the terrible shrinkage can be seen in the adjacent photos.
- 09.60.06** Flooring to complement acoustical needs for room for meeting acoustical requirements defined under **Room Acoustics** and **Noise** above.
- 09.60.07 Wall Bases** – generally use 4" vinyl or rubber to match existing materials in room. If a vinyl or rubber base, use pre-molded corner shapes.

DIVISION 10.00.00 SPECIALTIES:

10.11.00 MARKER AND TACK BOARDS:

10.11.01 Size:

- 4' high x as long as possible w/ absolutely flat porcelain on steel surfaces.
- At lecture/auditorium spaces, if sufficient height exists, markerboards maybe installed below projection screen.
- In ALC's, 6' high continuous markerboards covering walls adjacent tables should be provided. Dual writing/projection surface should be provided to accommodate projection.
- All GPCs except large auditoriums are to have markerboards.
- Provide with aluminum trim and tray, concealed spline connections.
- Furnish with 50-year warranty against surface defects, de-lamination from the backing materials, shadowing after erasing, etc.



10.11.02 Location:

- Provide markerboard WRITING surface at the instruction end and at sidewalls (except where student tech stations may be against walls – markerboards may also be required at rear wall).
- DO NOT place behind technology podium areas where podium will block view of lower part of chalkboard from student seating positions.
- Set trays at 36" AFF.

10.11.03 Add-ons:

- Tack-boards:
 - ONLY IN STUDENT TECH LABS – include tack surfaces on each side wall and back wall to allow special postings, with minimum of 4' x 10' behind printing stations.
 - In other classrooms – only place 4' h x 4' to 6' wide tack boards near rear entry doors.
 - Tack-boards to have surrounding aluminum frames and hidden fasteners.

10.11.04 Whiteboards:

- Polyvision Ceramite E3 porcelain enamel finish face sheet – color 6100 white, laminated to 7/16" MDF with .008 aluminum balance backing sheet.
- Framed with Deluxe series satin anodized aluminum extrusion. Includes full length AY-10 chalk tray with end caps, also includes full length 1" map/display rail with end stops, flag and map holders.
- If provided, the right markers and dry erase fiber cloths, one cloth per every 4' (or fraction thereof) of markerboard that do not damage the surface are to be furnished by OPP custodial staff, Black color only.
- Special consideration maybe given to Dry-erase paint. Products by Sherwin-Williams or Ideapaint should be used.

10.11.05 Definition in construction documents – include board(s) sizes, mounting information, hidden fasteners, top cork tack strip and hook rail, hooks, tray and specifications on construction documents.

10.14.00 ROOM SIGNS:**10.14.01 Required:**

- Room numbers and "**Classroom**" or "**Computer Classroom**" is to occur at all classroom doors - see Sign Standard at OPP and adjacent example. Also include the Braille for these raised letter signs occurring with room number in a 6" x 10" frame or as modified – coordinate with Scott Hord. Color of the top portion needs to match existing corridor signs, along with color to match Classroom information holder. Bottom portion of room sign should always be white with black letters. This sign should also include "**No Food, Drinks, or Tobacco-Use Allowed in Room**" and "**Doors Locked? Call Classroom Hotline (814)865-6000**", see example to right.
- OPP [PSU Interior Sign Manual](#) defines signage system and type.



CLASSROOM
CONSTRUCTION



10.14.02 Other signs:

- a. Beside each main door **exiting** a classroom place a 6" x 6" sign reading "**Do Not Remove Tables, Chairs or Tech Items – These Are Classroom Materials**". The color is to be PMS-#287C with white letters. An example is at right.

- b. Place beside or above each help phone (though no closer than 3") with the phone within arm length of the instructional technology podium, a special 6" x 8" call information sign. The sign is to have the "**Room Number and BUILDING NAME**", "**Tech Helpline 8-777-0035**, help hours **Monday through Friday 7:30 AM to 11 PM, Sunday 10 AM to 2 PM**, "**Environment/Room Hotline 8-863-6000**", "**University Police 8-863-1111**" and "**Safe Walk 8-865-WALK (9255)**".



An example is provided for 207 Osmond (with different hours shown) – verify Tech Helpline number as it can be different in different buildings. **Examples: Thomas is to list first 8-8633-8506, then 8-777-0035; Willard is to have 8-865-8254, then 8-777-0035.** The color is to be PMS-#287C with white letters. Also help hours may vary so check with members of the **Instructional Support Group** prior to final fabrication.

- d. Include horizontal 13"x12" or vertical 10"x 13" slip-in sheet "**Classroom Information**" sign frame and transparent cover to be mounted as follows:
1. At each Classroom door – one "Classroom Information" holder above, below or beside each GPC door sign – always mount vertically as shown above by the GPC door sign. The color is to match existing building corridor sign colors. Need to field verify.
 2. At each Computer Classroom door – two "ad-hoc" information frames, 1 above and 1 below each room sign or as otherwise noted – again, always mount vertically.
 3. At front of all classrooms above or very near help phone (and no closer than 3" to the phone) – horizontal or vertical depending on room layout chart that will be placed in frames. Contact GPC FC for mounting direction.

DIVISION 11.00.00 EQUIPMENT:**11.52.00 PROJECTION SCREENS:****11.52.00 General – applies to all projection screens:**

- a. ANSI/INFOCOMM V202.01:2016 should be utilized to establish optimum screen size, farthest viewer and closest viewer for room configuration.
- b. **Image Area** - provide motorized with seamless, matte white finish, as large as possible, depending on room size. See below. Da-Lite screens, Model: Cosmopolitan Electrol, with heavy black backing are recommended. Avoid side-tab tensioned screens.
- b. **Quantities** – a minimum of 2 screens should be provided in each classroom, lecture and seminar room, even the small ones.

c. **Viewing:**

1. Align screen so that 60-degree sight lines left and right from each screen edge cover all student seats.
2. The vertical angle for the front seated viewer to the top of the image to not exceed 30-degree to floor at student viewing height.

d. **Construction Documents** – note screen angles and dimensions on plan to allow exact placement in field to avoid wall mounted projections (wall lights, chalkboards, etc.).

e. **Screen Size:**

1. Screen proportions for all projection screens installed in the GPCs are to be the 16 to 10 proportion.
2. Size main screen width to most distant viewer - use a ratio of 1 to 3.25. *Example - 32' to most remote viewer gives an 9.84' wide screen; Use standard size as much as possible such as 6' x 9.6' available in this model.*

f. **Screen Mounting Height** – Set high and fully recess housing into the ceiling so that bottom edge is flush to the finished ceiling plane and to keep bottoms of viewing area 42" or greater above floor.

1. Screens shall be designed to have as minimal amount as possible of black screen drop so that screen fabric is "fully hung" in order to keep as stretched as possible.

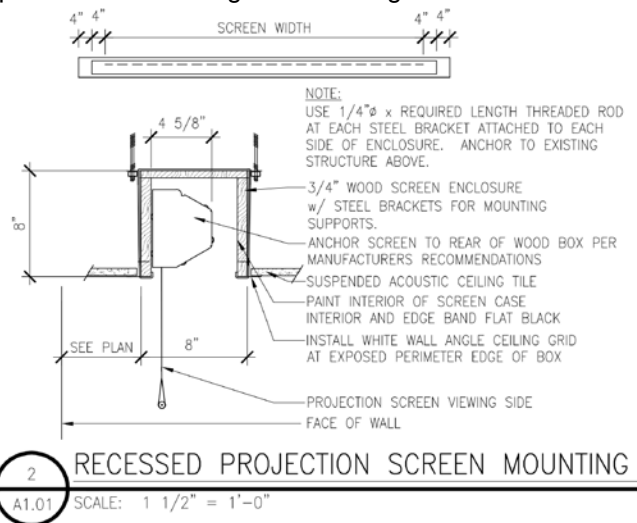

g. **Recessed Screen Housing & Ceiling System** – do not tie together. Build box around screen unit not equipped with box so that components of the screen unit can be dropped out for maintenance or replacement without destroying ceiling, soffits or other surrounding finish materials. See detail example in illustration bubble 2/A1.01 below.

h. Mount so that in the down position it will clear wall-mounted lights at chalkboards, chalk trays or other protrusions.

i. **Suggested local source for the Da-Lite screens:** State College Audio Visual Supply.

11.52.01 Motorized Main Screen:

- a. Fully recess into ceilings at ALL locations unless identified otherwise in writing w/LSLC-O&T.
- b. Use engraved **SCREEN - UP, STOP, DOWN** control switch to operate screen movement.
- c. **MOMENTARY SCREEN CONTROL SWITCHES ARE NOT ACCEPTABLE. THERE MUST BE A CENTER OFF POSITION AND SUSTAINED ELECTRICAL CONTACT WHEN SWITCHED TO "UP" OR "DOWN".** Screen units have limit switches that stop screen up and down movement.
- d. Screens 7' wide and wider to be motorized, unless defined otherwise by the **LSLC-O&T**.
- e. Recess fully into the ceiling all main screens used in conjunction with ceiling mounted tech projectors fabricate 5-sided wood boxes to house the smaller screens not equipped with the wood boxes;

anchor wood box securely to building structure, not ceiling grid system.

- f. In rooms with over 60 student seats, two main screens to be provided – possibly three or more in auditoriums. In such case the manual second screen is not necessary.
- g. Co-ordinate the electrical screen needs with the piping, duct and other building equipment section 20.01.03 and electrical conduits, wireways, etc. section 26.05.06.
- h. Do not use screens with the door panels that close with plastic hooks that catch the screen fabric bottom bar as it approaches the doors. The plastic hooks are too weak and break causing problems for the screen fabric and total retraction of the fabric. Also use the linear motor drives where motors at the end of the screens will not work due to space restrictions.

11.52.02 Motorized Second Screen:

- a. Size width to room, but no less than 1 to 6 ratio screen width to most remote seating position.
- b. Identify exact height from bottom of screen housing to floor, again as high as possible and when extended, no less than 36" AFF, 42" preferred.
- c. Do not hang screens from T-bars as hangers pull down – ceiling edge angles may be fasted to such boxes.
- d. Hang screen housing inside 5-sided box recessed into ceiling as pictured and noted above.

11.52.03 Fixed Screens:

- a. May be used where bottom is over 7' AFF and wall space from this level to the ceiling is sufficient – exception – in auditorium where all viewers can see a lower bottom (generally in tiered spaces).
- b. Mostly restricted to auditorium type classroom environments.
- c. To be angled at top toward GPC to minimize keystone effect from cart-mounted overhead projectors – work with **MTSS** for projector location for particular screens.

DIVISION 12.00.00 FURNISHINGS:

12.20.00 WINDOWS & WINDOW COVERINGS:

12.20.00 General to Window Coverings:

- a. Provide shades at any classroom/seminar/lecture rooms having exterior windows.
- b. Windows in auditoriums shall be carefully located to not create glare.
- c. Mount tightly to window frames to prevent light spill around ends.
- d. If chains are used, they are to be long enough to allow wheel chair bound people to operate. Window covering operating mechanisms (such as chains, rods, ropes, etc.) are to be ADA accessible.
- e. Mount such window coverings to clear any hardware projections (when fully extended toward the room side of the window) at all windows being covered.
- f. Provide enough recessed pocket space at ceiling system or window recess to allow proper placement of the shade system.

- g. Construction documents in design phase to include adequate space in area over window openings for such window cover housings, including adequate space to allow easy maintenance and servicing.
- h. **Venetian blinds or drapes** are not desired. If necessary due to special circumstances, they are to have non-plastic and heavy duty operating components.

12.20.01 Opaque & Light Filtering Window Coverings

- a. Windows to have light filtering coverings. Opaque blinds to totally cut out all light entry into room shall be added where specifically reviewed and required by anticipated and unique requirements.
- b. Dual roller blinds, with translucent layer opening density adjusted for light exposure for particular building elevation most desired, such as MechoShades – 55 Rorer Avenue, Hatboro, PA 19040 – Richard Rosenbaum, email: richardr@mechoshade.com.
- c. Where required due to larger size, use Mecho/5x mechanism designed to accommodate larger shade.

12.20.02 Window locks - required to operable windows at spaces with air conditioning.

- a. Building staff can open windows until non-functioning HVAC systems are operational.

12.20.03 Mullion sun light shields - Provide vertical mullion extensions to prevent exterior sun light from passing between adjacent shade units. Sun light is not to hit projection screens.

12.50.00 FURNISHINGS – SPECIAL EQUIPMENT:

12.50.01 Student seating - general:

- a. Locate front row back from room front sufficiently to allow all student positions to be within the 90-degree side-to-side viewing cone and up to the 30-degree vertical viewing angle identified for viewing all screens. See **Visuals** and **Screens** noted previously for more definition of this minimum distance to the front of the classrooms.
- b. Fixed seating attached to rows of tables not accepted unless demonstration unit is accepted and noted in writing by the **LSLC-O&T**. Such attached seats do not accommodate large or tall users.
- c. Fixed and continuous tables acceptable in auditorium and large classrooms with movable chairs on casters.
- d. Moving SSTs to be considered for all other classrooms with loose furniture used for student positions.
- e. **CLEARANCES:**
 1. Where possible, keep 4 to 5' between the last row of any seating type and the rear wall to handle projectors and foot traffic (except auditorium seating where a few seats can be left out for a projector position).
 2. At fixed seating, check with **MTSS** to see if space is necessary at the rear wall for projection equipment. If so, do not place seats in this position. Coordinate w/ **LSLC-O&T-FC** and **MTSS** for space that should be left clear.
 3. Chapter 17 of the 2009 International Building Code has requirements related to row spacing that could require greater distances between rows of student seating. Please comply with the requirements when the spacing is over 36" of free space between adjacent rows.

12.50.02 Square footage requirements for seating types:

Room shape, function, and configuration causes a wide range of square feet for each seating type. In no case is the square footage for a type to be less than the minimum noted below and should fall close to the center of the range for each category.

- a. **AUDA** – Classroom Lecture Hall with Auditorium seating having single movable writing surface – 10 to 16 square feet;
- e. **AUD2** – (AUDA w/ 2 tablet arms per seat) – Classroom Lecture Hall with Auditorium seating having dual movable writing surfaces – 15 to 20 square feet.
- m. **FTLC** – Fixed Tables and Loose Chairs – 25 to 42 square feet;
- p. **STAB** – (SSTs) Stackable Student Table and Chair – 18 to 25 square feet;
- r. **TABL** – Moveable Tables and Chairs – 22 to 85 square feet;

**AUDA****AUD2****12.50.03 Student seating Space Planning Parameters:**

- a. **AUDA** – Classroom Lecture Hall – these seats are auditorium type with a movable tablet arm - maintain no less than 39" from seat back to seat back, and preferably 44".
- e. **AUD2** – Classroom Lecture Hall – (AUDA w/ 2 tablet arms) – these use dual tablet arm chairs fabricated specially for PSU by KI. Keep all seating at no less than 39" with 44" preferable when measuring seat back to seat back, to allow passage of students when writing tablet surfaces are being used.
- K. **FTLC** – in auditorium or other arrangements with fixed tables, keep at least 36" for the seating distance between a row's rear table edge and next row's front edge for loose chairs, & 30" side ways for each student position.
- M. **STAB** – maintain at least 36" for the seating distance between rows of SSTs and 28" side to side for each student position and no less than 36" for aisles (no less than 48" when chalkboards at side walls) unless distances changed and okayed with the **LSLC-O&T**.
- O. **TABL** – use a spacing distance front to back of 30 to 36" (verify code) between table edges for sled or wheel based chairs, & 30" of width for each student position. Tables should be 20" deep minimum.

**FTLC****1. Table Construction:**

- a) At student seating positions, table legs are to be tight to the corners and ends of tables for all table sizes, including 5', 6', 7' or 8' tables. Legs shall **NOT** be recessed or set back from the table ends 4" to 18".
- b) Tables to meet BIFMA X5.5-2014 Standards including loading of 300 pounds of superimposed load.
- c) Table edges to be heavy duty extremely durable material and glued to not be removable by knife or other sharp objects users may possess.

**STAB**

2. Example of special “Heavy Duty” STUDENT table developed for PSU - Versteel Specification:

a) Ordering Information:

Versteel c/o McCartney's, Inc.
 2332 Cathy Lane
 Jasper, IN 47536

Contact: Mary Beth Schmidhamer
 Tel: 814-505-1143
 Fax: 814-949-6197



TABL

b) **Penn State University Special “Heavy Duty” Versteel Classroom Table:**

1) Reference sizes and special order numbers are as follows:

- 24” x 48” table – Special VETC2448REFX
- 24” x 60” table – Special VETC2460REFX
- 24” x 72” table – Special VETC2472REFX
- 24” x 96” table – Special VETC2496REFX

c) **Standard Duty Tables with locking castors and tilt/nesting capability:**

- 1) Kimball, “Dock”
- 2) Kl, “Pirouette”

d) **Programmed Seat Counts:**

- 1) When seat count is given in a program or other document that seat count is the number to be placed in the room, even if square footage needs to be larger than programmed.
- 2) Squeezing the required seat count into too small spaces will not be accepted.
- 3) Reduced front instructional area or aisles will not be accepted to achieve the required seat count.
- 4) If the acceptable seat count cannot be achieved this must be documented in writing and graphical form by the architect who will then forward the information to the **FC** via the PM or PC. The **FC** will convey the situation up the chain for a response that will be documented in writing or by email.

e) **Accessible wheel chair seating:** Provide positions, distributed in each classroom or classroom/lab space, according to the following table:

CAPACITY OF SEATING IN ROOM	MINIMUM REQUIRED NUMBER OF WHEEL CHAIR SPACES
4 to 25	1
26 to 50	2
51 to 100	4
101 to 300	5
301 to 500	6
501 to 5,000	6 plus 1 for each 150 or fraction thereof, over 501

12.50.04 Labeling: “GPC” – to be stencil *printed* on the bottom of all loose classroom furniture items in 1-1/2” to 2” high contrasting color block letters.



12.51.00 Seating Types:**12.51.01. Classroom Lecture Hall Auditorium Seating:****a. AUDA, AUD2**

1. 22" and wider seat pans are to be used. If wider sizes become available these should be considered.
2. ADA required positions are to also be equipped with writing surfaces and the chairs defined below, to allow full use by other students when wheelchair users are not in the ADA required locations. Provide "Transfer" aisle chair as required by IBC Section 1108.
3. 15% at least, of the auditorium seats, if AUDA, are to have BOTH left and right-handed tablet arms on the same chair for use by both left and right-handed individuals. KI has prototyped such a seat for PSU usage. Contact for space requirements to be sure the programmed and required seat count can be achieved.
4. Power may be required to run to all seat rows for use with laptops – coordinate with LSLC-O&T for exact details (power is definitely required at fixed student tables in auditorium type classroom environments).

b. AUDA, AUD2, FTLC & STAB

1. Critical to have distances defined above to allow movement when exams underway.
2. Table surfaces to be minimum 16" front to back and to have full-length front modesty panel, except at wheelchair positions, where the front panel would not allow the wheelchair user to get close enough to the writing surfaces.
3. Power outlets are required between pairs of seats for power. Data outlets no longer required in student tables as classrooms are to be equipped with wireless internet capabilities.
4. Heavy T-spline edges to be used on all tables at student positions. The T-molded spline edge is to be additionally glued in place. Do not use laminated plastic edges.
5. Chair type – to be capable of swiveling, have casters appropriate for the type floor surface the chair is to be located upon and is to have only a lever to raise or lower seat. No arms, knobs or back leaning or back height adjustments. Chairs are to have durable fabric and construction with minimum of 10-year warranty on all parts and fabric. Example of this chair type used as specification standard - KI Torsion Pedestal, model TPNAU, armless, casters, fabric covered with only rising & lowering control lever. **Departments or colleges that require more than this basic seat configuration will be responsible for replacing such seats in the affected GPCs.**

12.51.02 Seating with tablet arms, when used (mostly for large classroom lecture hall auditorium seating – single tablet arm no longer desired in GPCs – use dual tablet arms for such seating):

- a. Tablet surfaces to be largest model available (for laptops and paper) and not less than 212 square inches (280 square inches preferred) at the writing area.
- b. >15% in a room are to be for left handed users.

- c. Tablet surfaces are to have reinforced supports to prevent breaking of tablet arm when sat on by 350-pound individual.

12.51.03 SSTs - student stacking tables

- a. **24" wide x 19" deep x 30" high by CORT** Special Projects Group, 11250 Waples Mill Road, Suite 500, Fairfax VA 22030 - 800-565-2678 - Dan Huber
- b. **26" wide x 20" deep x 30" high by KI** - their Intellect model #ELD30-SX-ENTBL-GL unit modified for PSU with Starlight Silver Frame finish (SX), Flannel top (FN), glides (GL), with KI "Nickel evolve" (LNV) laminate plastic top, 3457 Babcock Blvd, Pittsburgh, PA 15237 - 412-921-2611, ext 12 - Dave Whiting.

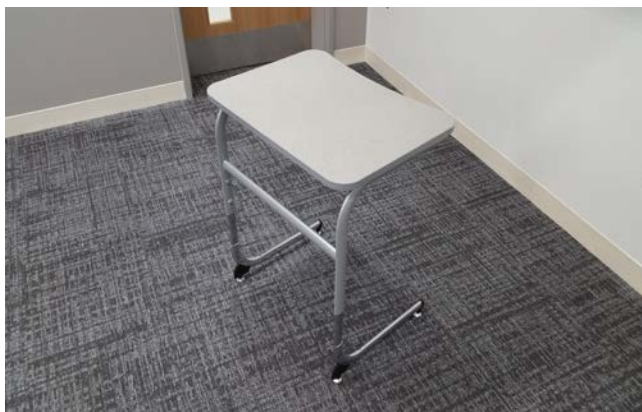

- c. 36" wide x 20" deep x 32" high by KI – these are their ADA sized tables to be used at positions dedicated to wheelchair users. #EDADA
- d. All SSTs to have "C" support frames, with tops, edging and frame finish as noted above.
- e. See section 12.50.04 for the required stenciling on the bottom of the loose furniture.

12.51.04 Student and instructor chairs - perforated seat/back with castors

- a. Example: **Sit On It – Anytime Side Chair #93FCS.AO.SC1.C13** – silver frame, black seat and back, armless with 4 leg carpet castors
 - 1) Supply Source, 200 Calder Way, State College, PA 16801
814-237-2660 – Jennifer Peck
 - 2) Educational Furniture Solutions, 536 N. Trooper Road, Norristown, PA
610-630-3995 – Kevin Christman
 - 2) Top to Bottom Interiors II, 1009 E. College Avenue, State College, PA 16801
814-234-8880
- b. See section 12.50.04 for the required stenciling on the bottom of the loose furniture.



12.51.05 Instructional and student laboratory technology seating stations – tables, chairs, etc.

- a. **Leg positions and other requirements** – see 12.50.03 f. 2. for very important table construction requirements.
- b. **Full size samples submittals** – all seating, tables, podiums, cabinets, etc. are to have such submitted to the **LSLC-O&T** for review and approval before placing such products out to bid. See 12.51.01 b. 5. above for another chair type noted under AUDA 3 heading.
- c. **Technology tables** - to have hidden-from-view and integrated wire management systems that are continuous from one table to the next and to the point of connection with the building infrastructure.
- d. See section 12.50.04 for the required stenciling on the bottom of the loose furniture.

12.51.06 Instructor table (and in some cases student tables – see previous picture):

- a. Folding w/ modesty panel.
- b. By KI – model #PINR2460T-54B Pirouette Nesting Training Table 24 x 60, frame color STARLIGHT SILVER, edge: WARM GREY, top laminate: NICKEL EVOLV – Corbett Inc., 401 Greentree Road, Pittsburgh, PA 15220, (412) 921-2611 – Dave Whiting.
- c. See section 12.50.03, 2.c for other approved table.
- d. See section 12.50.04 for the required stenciling on the bottom of the loose furniture.

12.51.07 Instructor stool at instructional technology podium:

- a. Product example currently in use is the KI Strive Stool, model #SPSNAU, with height adjustable control paddle that operates a pneumatic cylinder. Stools are to be without arms. Base it to be with 5 legs for casters.
- b. KI Strive Stool frame color to be epoxy powder coat - black (BL), with casters appropriate for the floor finish in the GPC to receive the stool. When fabrics are used, they are to be Skyline Black 1KBN, and to withstand at least 200,000 double rubs
- c. See section 12.50.04 for the required stenciling on the bottom of the loose furniture.

12.51.08 Loose Student Tables – See above section 12.50.03 – j) – 2).

12.51.09 Instructional Technology Podium – See section 27.41.06 for podium information.

12.51.10 Trash and Recycling Containers:

- a. As of January 9, 2017, ALL trash, mixed paper and plastic recycling containers will be removed from ALL General Purpose Classrooms.
- b. Occupants will need to locate the 7-gang recycling stations in the corridors to dispose of any recycling materials per the PSU Mobius Program, <http://sustainability.psu.edu/recycling-and-composting>
- c. Computer classrooms (STEC) as designated by TLT Classroom Department, will be an exception and will have mixed paper cans at each printer station
- d. Coordinate functional considerations closely with the **LSLC-O&T-FC** and **Erik Cagle**, Manager Custodial Operations, at 814-863-4095 and ejc17@psu.edu, **Nadine Davitt**, Supervisor of Refuse & Recycling, at 814-865-6606 and njh103@psu.edu

DIVISION 20.00.00 PLUMBING, HVAC, FIRE SPRINKLING SYSTEMS, ETC.:

20.01.00 GENERAL TO PLUMBING, SPRINKLING SYSTEMS AND HVAC NEAR CLASSROOMS:

20.01.00 NOISES, VIBRATIONS AND VISUAL CONSIDERATIONS TIED TO PLUMBING, SPRINKLING AND HVAC COMPONENTS:

20.01.01 Pipes:

- a. To be dense and well insulated (cast iron pipes) for rain-water, and other pipe conductors close to classrooms. Pipes are not to touch the finished surfaces. Minimize sound transmission into the classroom of running water. Comply with ANSI/ASA S12.60-2002.

- b. All pipe penetrations through walls, floors or overhead slabs are to be isolated and caulked at the penetrations to prevent sound transfer.
- c. If baseboards used, ALL pipes to be hidden by the covering – none below the shroud.

20.01.02 HVAC and Air Movement:

a. Room Air:

1. Use air-handling systems with low velocity discharge diffusers.
2. Design and install systems that isolate machine and other air noises from classrooms and classroom equipment.
3. Size ducts, diffusers and air returns large enough to achieve a noise free “library quiet” environment. ASHRAE minimum requirements are not low enough for classrooms.
4. Noise level is to be no higher than NC = 30 in general and NC = 20 at grills or registers.
5. ANSI/ASA S12.60-2002 sets 35 decibels for maximum background noise for unoccupied school classrooms – this is too high and needs to be 30 decibels or lower.

b. Transfer grills

1. Not allowed in doors or corridor walls.
2. To be used to equalize air pressure of auditorium classroom spaces on both sides of large-attached-fixed projection screens.

- c. **No open return air plenum space between ceiling and structure** – due to need for electrical components for ceiling mounted technology projectors and document cameras, and wireless computer system receivers/transmitters.

- d. **Diffuser throw** – orient so that air from diffusers does not hit any projection screens, nor any ceiling located data tech projectors. Use three way diffusers, as illustrated to right, to keep air from blowing onto these audio-visual components.

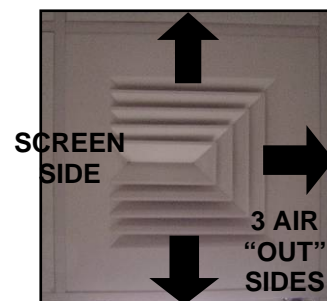

e. HVAC system for classrooms:

1. Zone independent of rest of building so zone can operate the entire year during class hours, whereas the rest of the building system may have the AC functions disabled during late fall, winter and early spring.
2. Maintain proper room air exchanges at all class occupied times, during both the cooling and heating seasons and size for the people loads, any heat generating and technology equipment loads, as well as loads from adjacent side, below and above spaces.

f. Cooling for GPC Technology Equipment “Closet”:

1. The space will be placed close to or within the instructional space for today’s electronic computer and teaching systems, particularly in classrooms generally larger than 100 seat capacity.
2. Provide generous ventilation and cooling beyond current design needs – item 4 this heading (as equipment is upgraded, it most likely will generate more heat with the greater number of features that continue to evolve for education).
3. Closely coordinate with the **ITS-TLT** and **MTSS** representatives.

4. Provide cooling capacity that will adequately maintain a maximum room temperature of 70° F 24 hours a day year around.
5. This room should have its own independent cooling system to keep the equipment cool at all times, as the equipment runs 24/7. This is true even with classrooms shutdown and locked as can happen between semesters and during special break periods. The cooling must continue even with the rest of the building cooling and heating systems are placed in conservation mode.

20.01.03 Piping, duct and building equipment interferences with GPC equipment:

- a. Route all piping, ducts and other necessary system components around the perimeter of the classroom and away from the front area of every classroom, **to keep the ceiling surfaces between the screens and projectors tight to the structure.**
- b. **Projection screens** require recessing to place the full projected image as close to the ceiling as possible – this is necessary to keep the bottom of the screen high so that students can see the full image even when at the back of a room.
- c. Projection equipment mounted near the ceiling usually from the building structure needs clear paths from the structure to the projector for the supporting pipe.

20.01.04 Building, mechanical and machinery noises and vibrations:

- a. Isolate from Classrooms, be the noise or vibrations from elevator, HVAC equipment and ducts, other kinds of motors or other noise generators (including light fixtures). Comply with ANSI/ASA S12.60-2002 for maximum sound and vibration levels allowable at classrooms.
- b. Building equipment vibrations transferred into building structure not desired as such vibrations can cause classroom ceiling hung technology projectors to bounce around. Do not allow this to happen.

20.01.05 Thermostats:

- a. Place locking clear covers over all room thermostats or temperature sensors to prevent tampering or use different units with setting controls separate (like above ceiling) from the wall sensor units.
- b. Locate away from chalk boards, tack boards, any cabinets to be installed in the classrooms and away from any heat producing elements in the room (including technology used in the educational process).

20.01.06 Fire Strobe Lights: Locate away from projection screens that may block sight lines to the strobes when screens are extended for projection.

20.01.07 Commissioning at classrooms – refer to section 40.80.00.

DIVISION 26.00.00 ELECTRICAL:

26.00.00 GENERAL:

26.05.00 CONDUITS, WIREWAYS, LOW VOLTAGE WIRES, OTHER WIRES, WIREMOLD and OTHER UTILITY AND SPECIAL CABLING SYSTEM NEEDS:

26.05.01 Commissioning at classrooms – refer to section 40.80.00.

26.05.02 Note that all such utility products are to be run behind the wall, ceiling, and floor finishes.

26.05.03 If exceptions are needed, identify them early in the design/construction process with the Classroom **FC** in which case they are to be limited to “special” surface applications absolutely necessary due to structural issues.

26.05.04 Special wire management systems: may be allowed on surfaces where they can be well integrated into the intended function and needs of the room. These signal cable and power wireways are to be identified early in the design process.

26.05.05 Conduits between projector and instructional technology podium:

a. Signal cable conduit:

1. 1 ¼” metal electrical conduit (no substitute sizes or plastic) to be used for control and signal cable from tech podium to **each** ceiling or rear data tech projector for cables with pre-molded ends (example: **NO BNC CABLES TO BE USED**).
2. 1 ¼” metal conduits may need to run to equipment racks in some rooms requiring more equipment than will fit in the instructional tech podium.
3. Again, note that a 1 ¼” metal conduit is to run from under the podium to above the ceiling for **each** ceiling data tech projector. Contractor to use sweep elbows unless structure prevents such use. Contractor shall then run conduit with no more than three (3) elbows. If necessary, or add adequately sized junction boxes to avoid stress/breakage on cables.

1. Alternate floor box from FSR, Inc.: FL-500P, <https://fsrinc.com/fsr-products/product/floor-box-fl-500p> box is fire rated and able to be installed in concrete, or metal deck.

<https://fsrinc.com/documents/spec-sheet/10498-lit1047q-fl-500-spec-pdf/file>

- b. 1” conduit required for power and power to be same phase, ground, neutral, etc. at a GPCs tech projectors, podium and equipment rack (where needed).

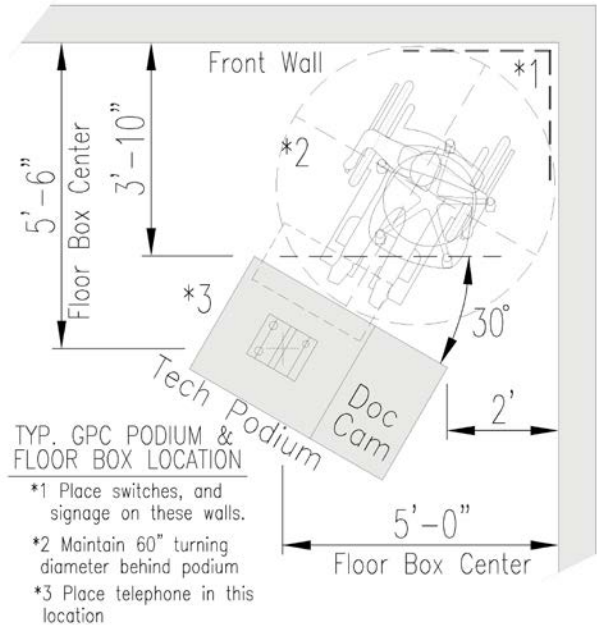

All data cables pulled into podium be terminated w/keystonejacks on a plate per floor box recommendations
20Amp 120VAC Duplex receptacle in floor box

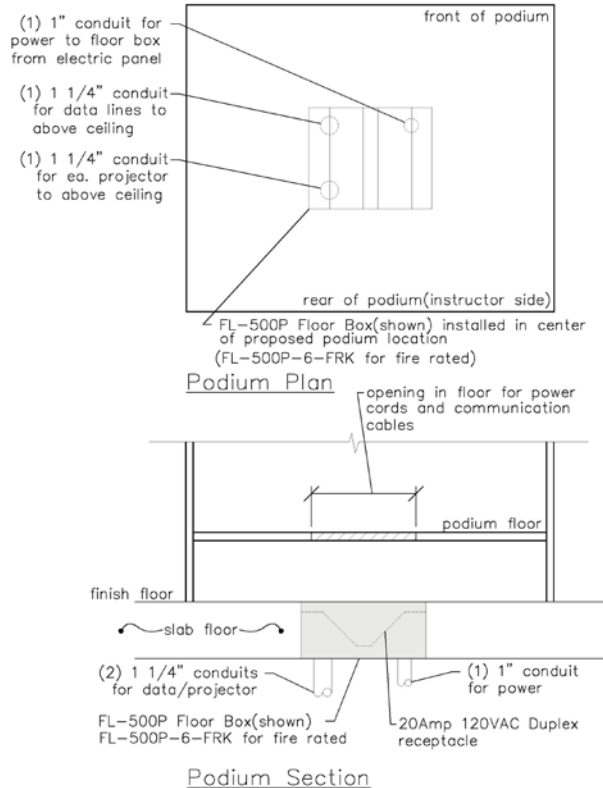

4. The ceiling data tech projectors may require relocation when replaced. Therefore, allow 8' of extra wire in flexible conduits above ceiling to allow this movement to occur without damage to the wiring.
- c. Floor penetrations for the conduits into the instructional tech podium are to be centered under the IT Podium and located so that the minimum 3'-10" and 2' dimensions are maintained behind and beside the podium.
- d. See **26.70.01** for wire management systems (wireways).

26.05.06 Conduits for Flat Panel Information Screens outside Computer Lab / Classrooms:

- a. Provide conduits to data outlets and security box in wall beside doors to such rooms to operate and secure the flat panel monitors.
- b. Conduits can terminate above accessible ceiling systems. Otherwise run to telecommunication closet.

26.05.07 Electric Screens: coordinate power needs, control switches, conduit locations and clearances with motorized screens as identified in section **11.52.01**. Device switches and cover plates are to be same color as other device plates placed in each classroom.

26.05.08 Pathways for Conduits and Cable Runs from each GPC to Other Termination Location Outside Computer Lab / Classrooms:

- a. Provide clearly delineated construction documents and drawings indicating conduit and cable runs from each Computer Lab / Classroom to the termination location for the other end of each run at the telecommunication room or other designated termination location.
- b. These conduits and/or cables that emanate from each classroom may be above accessible classroom ceiling systems or from junction boxes as defined for the technology needs in the classroom. Technology components must be upgraded every three to four years. Thus these routings, with locations for pull boxes and other boxes well defined, are extremely important to make successful tech upgrades.

26.50.00 CLASSROOM LIGHTS AND LIGHTING CONTROL:

26.51.00 GENERAL:

- a. Use energy efficient LED lights (90 lm/w or greater), with tight light ray directional control, 4000 degree K with minimum CRI of 82.
- b. Use 2'x2' or 2'x4' recessed light fixtures LEDs volumetric reflectors that diffuse the light and reduce glare. Accepted manufacturers are Ledalite ("PureFx" or "Shine"), Finelite ("HPR-1"), Corelite ("R1"), or as approved by lighting designer.
- c. Pendant direct/indirect fixtures between existing / new / future ceiling-mounted projectors and screens:
 1. **Do not use pendant light fixtures in these ceiling locations.**
 2. **Do not use any** within the front 2/3rds of the room – screens have to be dropped when such fixtures are used, which is not acceptable.

d. **Foot candles:**

1. Minimum maintained uniform light level at desk height is to be 50 FC, after LED depreciation and after dirt accumulates, use a 0.85 LLF to meet the minimal design level.
2. Final lighting (with all lights fully on and none dimmed) FC measurement to be in 12 spots from front to back, thus:

IL	IC	IR	(Instructor left section, center section and right section)
FL	FC	FR	(Front row seating, left, center and right at any seat in each section)
CL	CC	CR	(Center row seating, left, center and right at any seat in each section)
BL	BC	BR	(Back row seating, left, center and right at any seat in each section)
3. These 12 measurements will be averaged to check the illuminance in each classroom before project closeout – any “under-designs”, especially at corners, will require additional placements of light fixtures.

e. **Lamp Replacement Serviceability and Maintenance:**

1. GPCs with sloped or tiered floors and high ceilings – very problematic for LED and ballast replacements. Consider how fixtures are to be maintained possibly by access via catwalks with railings or other easy access methods.
2. High ceilings defined - those that cannot be accessed in all GPC locations with a 10' ladder and require scaffolding to replace burned out equipment.
3. GPCs have very heavy use and bulbs burn out regularly. Such bulbs need to be replaced when they are seen to be burned out – not between semesters as is essential when scaffolding is necessary for re-lamping or replacing ballasts.

- f. For more information on electrical/lighting refer to [Design & Construction Standards Section 26 00 00](#)

26.52.00 DEVICE PLATES AND SWITCHES:

a. COLOR AND KIND:

1. Low voltage switches shall provide local control of lighting fixtures. Night products shall be the basis of design; refer to OPP design standards, section 260923.
2. All in a room are to be the same colors and material, including duplex or 4-plex outlets.
3. White device color and engraved stainless steel faceplates are preferred.

b. ARCHITECTURAL MULTI-SCENE CONTROLLERS:

1. Do **NOT** use unless cleared in writing with the **LSLC-O&T-Subcommittee**. Work with OPP Engineering Services, a 4-Button or 8-Button Scene Control separate from the group of Zone Controls is typically acceptable.

26.53.00 OCCUPANCY SENSORS:

- a. Use in all instructional/classroom areas and entry vestibules into classrooms.
- b. Sensors are to automatically shut off all lights about 30 minutes after no room activity is sensed.
- c. Lighting controls shall be manual ON/automatic OFF: Sensors are to automatically and **within 1 second** turn on the main room lights if shutoff occurs when room is still occupied.



- d. Use units only that mount high on walls or ceilings – not as part of light switches at entry doors.
- e. Dual-tech sensors shall be preference for lecture-style classrooms. Nlight model nCM PDT shall be basis of design. Exact type and range shall be specified according to design application.

26.54.00 GENERAL ROOM LIGHTING:

26.54.01 LIGHT SWITCH CONTROL LOCATIONS AND TYPE:

- a. Place at the instructor's area.
- b. Center on the rear wall ONLY in rooms having rear projection capabilities;
- c. Duplicate in rear projection booth, if any, and
- d. **Place at each room door.**
- e. Use only a single on-off switch at each entry/exit door position tied to main room lights.
- f. Locate lighting dimming controls only at the instructional and rear projection (if any) positions.
- g. Use pilot lights or illuminated panels to help locate all light control switches in the dark at the podium position.



26.54.02 SWITCH CONTROL ENGRAVING AND RELATIVE POSITION:

- a. Engrave all light control switch device plates only at instructional podium position and rear projection (if any) positions.
- b. Possible engravings for the lights operated – **FRONT, MIDDLE, BACK, BACK DIM, PODIUM DIM, TABLE DIM, BOARD, AISLES**, etc.
- c. Lettering to be minimum 1/8" high unless other size authorized in writing by **LSLC-O&T-FC**.
- d. Orient all switching positions and labeling to the room orientation.
 1. **Controls at side walls** - control front lights with front most switch, operate middle lights with middle control, back lights with back switch;
 2. **Controls at front walls** – control front lights with left switch, operate middle lights with middle switch, run rear lights with right one;
 3. **Controls at vertically stacked locations** – Mount main room light switches in one row. Mount other controls for screens and/or projectors in a separate row below or next to the room lights, again considering positions that best relate to the room location of each piece of equipment.



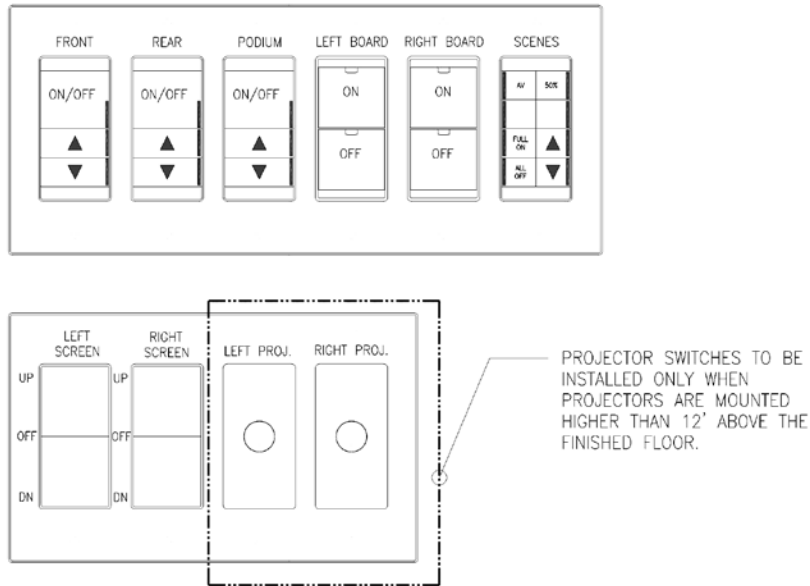

- e. All entry vestibules to have separately zoned vestibule light controls by each passage door in the vestibule.
- f. All ramps to or within GPCs with multiple seating levels to have light controls at each end of each ramp (to provide three-way switch function).
- g. Review egress lighting and controls for auditorium and classroom access with LSLC-O&T-subcommittee.

26.54.03 GENERAL ROOM LIGHTING ZONES:

- a. Ceiling-mounted, main room lighting shall be provided with a minimum of two (2) lighting control zones.
- b. Plan each lighting control zone to run parallel to the front wall. Lighting fixtures mounted between a ceiling mounted tech projector and screen shall be controlled as a “Front Zone”.
 - 1. Large GPCs may require special consideration and discussion with the ISG for layout of control zones.
 - 2. **DO NOT** place any ceiling light fixtures within 7’ in front of any projection screens, unless reflectors restrict lights directly downward to not spill or reflect onto screens.
- c. For Projects with Lighting Fixture Replacements/New LED Lighting Fixtures:
 - 1. All main room lights are controlled “ON/OFF” to 50% light level via single switch at classroom entry.
 - 2. Switches adjacent to the instructor station provide individual control of zones and dimming capability.
 - a) The instructor can adjust lighting levels of the individual overhead lighting zones via raise/lower buttons to suit their needs.
 - b) Chalkboard lights shall be on separate switches/zones for “ON/OFF” control to full brightness. Zones shall be separated to match extent of projection screen.
 - 3. An optional eight button switch may be provided at the instructor station with preset scenes. It shall be mounted in the same row as the individual lighting control switches. Typical scene controls are as indicated in the table below and are provided via an eight button switch (six scene buttons, raise button, lower button). Note, this is a typical control arrangement and the sequence

of operation should be reviewed with LSLC-O&T prior to issuance of construction documents. Large lecture halls should be addressed on a case-by-case basis.

SCENE CONTROL PROGRAMMING		
SCENE NAME	FRONT LIGHT LEVEL	REAR LIGHT LEVEL
AV	0%	50%
50%	50%	50%
FULL ON	100%	100%
ALL OFF	0%	0%

- 4. Automatic lighting shutoff requirements shall be satisfied by occupancy sensor. Upon detection of vacancy, the lights shall shut off after a time delay no longer than 30 minutes.
- d. For Projects Using Existing Multi-Lamp Fluorescent Lighting Fixtures:
 - 1. A minimum of 50% of the lamps in main room lighting fixtures shall be tied to the front zone and manually controlled on/off by switches at all entry/exit doors, podium and where applicable, the rear projection or booth area. The switch at the podium and rear projection/booth shall provide dimming capability.
 - 2. Remaining lamps shall be manually controlled on/off/dim at the podium and where applicable, the rear projection or booth area.

26.54.04 MARKERBOARD LIGHTING ZONE:

- a. Use a separate on/off, circuited and wall mounted light strip above the instructor’s chalkboard.

- b. Restrict light pattern to the markerboard, so that none spills onto the back of the extended projection screen or toward the students. This means separate zones behind separate screens.

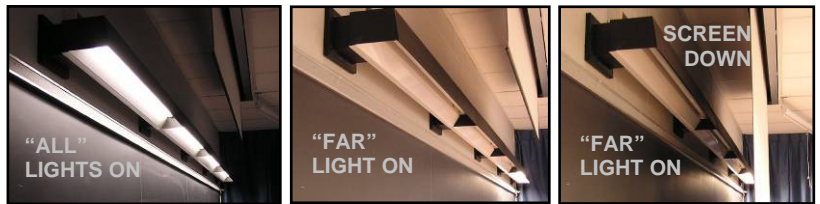

- c. Provide proper clearances to the fully extended screen.
- d. Mount switch with built-in pilot light on or near the instructional station.
- e. Properly label through 1/8” high engraving on the plate.
- f. 30 FC vertical (40 FC design minimum) lighting average is to be provided on only the instructional chalkboard surfaces.
 - 1. Use light meters with the sensing element oriented toward the student seating area, NOT TOWARD THE CEILING.
 - 2. Determine by averaging 9 points of a three row and three column matrix.
- g. Suggested product:
 - 1. Alkco surface mounted wall washer 7500 series.
 - 2. Lumax wall washer fixtures like WT13248-EO9MB 4’ T8 and WT11702-E09B-2MB 2’ T8 or LED versions as accepted by the LSLC-O&T subcommittee.



26.54.05 INSTRUCTIONAL PODIUM AND SIGNER LIGHTING ZONES:

- a. Confirm if a ceiling mounted podium light is needed.
- b. Review particular spaces with LSLC-O&T to determine if a podium or signer light would be required for project.

1. A very directional and adjustable fixture over the position - with no spill or wash on screens. A fully dimmable LED down-light with no more than **4000°K** is preferred, if viable to use.
2. Individual control, with dimmer switch having a pilot light, near the instructional station.
3. Locate fixture on room center side of the podium, at about "11 o'clock" or "1 o'clock", and a few feet on the student seating side of the position, to minimize instructor head shadows on reference materials.
4. Engrave switch plate with 1/8" high lettering.

26.54.06 INSTRUCTIONAL TABLE ZONE:

- a. Coordinate with LSLC-O&T for necessity of lighting fixtures for the instructional areas.
- b. Place a dimming directional light fixture over the instructor table (when included) with no spill or wash on the screens. Individually switch from near instructional station. Position in ceiling system at 3' on student side of table.

26.55.00 CLASSROOM EMERGENCY LIGHTS:

- a. General lighting fixtures with emergency functionality shall be controlled with normal lighting zone(s) and bypass to emergency "ON" via a UL 924 relay or transfer device.
- b. Where emergency lighting is provided via separate, designated emergency battery packs (with integral or remote heads); such lights are NOT to be on when the class is in session, unless all building power goes off. Use relay system to turn on these fixtures in case of power outage.
- c. Classrooms / lecture halls need the ability to be made totally dark. Within the exception of egress illumination required by IBC Section 1006.
- d. Fire-alarm strobes are NOT to be placed behind projection screens, which when extended block the light from the strobes.

26.56.00 CLASSROOM EMERGENCY EXIT LIGHT SIGNS:

- a. Use energy efficient LED type light signs where codes require emergency exit light signs.
- b. Orient exit sign lighting so that light rays do not shine onto the screen areas, causing image "color shift" or interlock via relay to light only when emergency power is activated.
- c. Exit sign color shall match existing in renovations and additions, for new construction provide green LED.



26.57.00 CORRIDOR SEATING AND STUDY COMMONS LIGHTING:

- a. Provide code minimum illuminance levels for the general traffic areas where bench seating is also located.
- b. Locate lights above bench/alcove and study commons areas that provide 50 FC of light for reading and writing.
- c. Locate light switches adjacent to benches for each bench/alcove area lights.
- d. If no benches and hallway is 8' or wider, provide 50 FC lighting in the corridors serving instructional rooms.
- e. Use occupancy sensor(s) in addition to local switches, to turn on-off lights.

26.60.00 SWITCH & DEVICE PLATE LAYOUTS ON WALLS:

26.60.01 Close to Instructional Technology Podium/Desk/Instructor Areas:

- a. Concentrate on a wall the multiple controls for lights, screens, ceiling mounted tech projectors and other components within 4 to 5 feet of the instructional tech podium in each room. Engrave each device plate for functional area – see below.
- b. Locate “**Help**” telephones near these controls, too.
- c. Provide in construction documents scaled elevation layout showing positions for all controllers, telephones, and other devices.
- d. Where projector is mounted above 12’, a key switch for powering on-off the ceiling projector shall be provided. Refer to section 27.41.02 for additional information.

26.60.02 At Other Areas:

- a. Light switches are required at all classroom vestibule doors and classroom doors, except one way emergency exit doors (no hardware on door outside room). These switches are to operate main body of room lights - only on/off.
- b. Device plates at doors do not need to be engraved.
- c. If rear classroom or building equipment booths are provided and lighting controls happen in the booth, the device plates are to be engraved with the same wording used near the instructional tech podium.

26.70.00 CONVENIENCE & DUPLEX OUTLETS:

26.70.01 In Classrooms:

- a. Front walls:
 1. Where conduits cannot be placed within the wall, run two-channel wire management system across front of each classroom and evenly space a minimum of 3 duplex outlets in the wire management system (Wiremold).
 2. Where conduits can be placed in wall, the wire way is not necessary, and a minimum of 3 duplex outlets shall be placed in the wall.
- b. Side walls – in addition to above requirement:
 1. Place at least two duplex outlets on each sidewall and space no greater than 16’ apart in classrooms **without** student technology.
 2. Place two-channel wire management system the length of the sidewalls in classrooms **with** student technology.
- c. Rear wall - place two-channel wire management system the length of the back wall in classrooms and evenly space 3 duplex outlets in the wire management system, if the conduits cannot be placed in the wall. If the conduits are in the wall, still provide a minimum of 3 duplex outlets in the wall.
- d. Wire management systems – to be mounted with tops just below chalkboard trays – same for other walls, again if the conduits cannot be fed within the wall from a chase position.
- e. Above Lay-in Ceiling:



1. Special outlets may need to be in special fire rated enclosures.
 2. Locate for ceiling mounted tech projectors.
 3. See previous requirements in section 26.05.05-b-4 for 8' of additional wire above the ceiling to allow the ceiling mounted data tech projector to be relocated when a new unit is necessary.
- f. At printer stations in computer-lab classrooms - Four-plex outlets to be provided above cabinet or above table top.
- g. At continuous student work surfaces where students sit in loose chairs (examples: Wartik 108, Life Sciences 100, IST 113).
- h. Special needs will be further defined for computer lab/classrooms and computer driven informational signs.

26.70.02 At Benches, Alcoves and Study Commons at or near Classroom Corridors:

- a. For laptop computer use, space duplex outlets at 3' intervals above benches.
- b. Use non-removable screws for the cover plates.
- c. At Study Commons locate outlets on each column face and on walls at 5' intervals.

26.70.03 At Flat Panel Information Screens outside Computer Lab / Classrooms:

Provide clock outlet in wall beside doors to such rooms for power to the flat panel monitors.

- 26.70.04** Refer to **27.41.00 AUDIO-VISUAL and TECHNOLOGY** and **DIVISION 28.00.00 SECURITY** for more detail on conduits, power, cabling, etc. that would most likely be performed by the electrical trades.

DIVISION 27.00.00 COMMUNICATIONS:

27.00.00 GENERAL:

- a. Closely coordinate design for sequence of installation of all communications, media tech, security and other instructional technology. The final sequences to placing these components into the instructional technology classrooms and labs are basically as follows:
 1. All conduits and non-conduit pathways for wires must be identified, in place and made easily accessible before any installation activities can begin.
 2. Power to be installed at floor under podium and at data projector and at other required positions.
 3. Podium is then set.
 4. Cables for data, phone lines, cable TV and security connections are run to equipment from central connection points.
 5. Technology, telephone and data projectors are set in place in podium, at ceiling, at wall and at racks where racks are needed.
 6. Cable connections are made to equipment for data, phones, cable TV and security.

7. Testing and adjusting of equipment and control codes occur to be sure all parts “talk” to each other and function as intended.
- b. More complex systems such as interactive video conferencing capabilities require additional considerations due to use of cameras, microphones that when activated move cameras and more cabling.
- c. Critical to the timely occurrence of the above sequence:
 1. Contractor and sub-contractor work;
 2. Material and equipment coordination, ordering many audio-visual and technology components, purchasing, delivery and placement.

27.30.00 TELEPHONES:

- a. Include in each technology classroom / lecture hall.
- b. Provide necessary outlet, wiring and conduit.
- c. Used as an intercom with a central computer/MTSS technician’s office, shop, or network room.
- d. **Locations in Classrooms:**
 1. In instructional technology classrooms – locate on wall closest to instructional podium or as designated by PSU -LSLC-O&T members.
 2. In conventional classrooms – locate right beside the chalkboard at the instructional end of the room in probable vicinity of future instructional technology podium.
- e. Coordinate early in project cycle and identify installation time frame with ITS-TNS and ITS-TLT to allow proper and timely installation during construction, not after finishes are installed.
- f. See section **27.41.05 TECHNOLOGY OUTLETS / POWER / CONDUIT NEEDS** for more specifics.



27.31.00 WIRELESS COMPUTER SYSTEMS:

- a. Evaluate possible use for each building project in the classrooms and immediate areas outside classrooms.
- b. Coordinate closely with the **LSLC-O&T** since their groups will be taking care of the systems.
- c. Include in design documents separate conduits for data and power for outlets at the wireless components.

27.32.00 INTERACTIVE VIDEO CONFERENCING SYSTEMS:

- a. Evaluate possible use in the classrooms for each building project.
- b. Coordinate closely with the **LSLC-O&T** representatives since their groups will be taking care of the systems.

27.33.00 INSTRUCTIONAL TECHNOLOGY CABLING: refer to **27.41.05 c** for further requirements for technology and conventional classrooms.

27.40.00 SOUND SYSTEM:

- a. Question need in each classroom for an instructor wireless and/or fixed microphone and room speakers.
- b. Consider technology and power needs as well as use of ADA hearing assisted devices and receivers for the audio and/or visual impaired.
- c. Use speakers tied via switcher/routers to the computers, CD Roms, DVDs and VCR's, in all cases.
- d. Refer to above comments under the **27.41.04 CONVENTIONAL AV POWER / CONDUIT NEEDS** heading.
- e. Coordinate with **MTSS** leadership.
- f. Plan for speaker locations - in podium, at/in ceilings and/or on the walls (least desired). No conduits or wires on room finish surfaces.

27.41.00 AUDIO-VISUAL and TECHNOLOGY:

27.41.01 TECHNOLOGY EQUIPMENT "CLOSET":

- a. If needed, place close to the instructional space for today's electronic computer and teaching systems.
- b. Provide for a securable, *well-ventilated "closet" / cabinet* with extending shelves for server equipment.
- c. Closely coordinate with the **ITS-TLT** and **MTSS** representatives.
- d. Locate in space so that access is possible from the front AND the back of a rack.
- e. See door and 5-push-button combination lock requirements noted above under **08.70.00 HARDWARE (DOOR)**.
- f. Proper conduits identified elsewhere in this document to run into this room from the instructional tech podium(s) and the ceiling projector(s) and speakers.
- g. Provide at least one quadraplex outlet 36" above floor. Add more outlets as needed to meet tech equipment load requirements. If more are needed, locate horizontally every 4' along the walls around these technology equipment rooms, same phase, ground, and neutral as that of the instructional tech components used in the GPC.

27.41.02 POWER AND CONTROLS:

- a. Provide 2 duplex outlet for each projector at the ceiling, and a duplex outlet for computer at the podium/instructor on same circuit.
- b. Locate such outlets in each classroom space.
- c. Provide same feed with a common, same phase, same ground and neutral power circuits in a GPC that are clean of ambient and stray signals for the podium/tech projector circuit(s).

- d. Include cabling, 1 ¼" **conduit (no substitute sizes or plastic)**, and boxes for controls between the podium and each of the projector positions.
- e. No other powered items are to be tied into these circuits supporting instructional technology.
- f. Only Provide a keyed switch for the power circuit(s) to the ceiling mounted tech projectors in GPC with ceiling height at projector over 10'-0" AFF.
 1. Locate keyed switch(es) next to other ganged switches on the wall near the instructional tech podium. Where are these to be used? In rooms with ceilings and data tech projectors mounted from ceilings that are over 10' off the floor.
 2. Key switch to match Leviton 20 Amp, 120/277 Volt, Key Locking Single-Pole AC Quiet Switch, Extra Heavy Duty Spec Grade, Model 1221-2KL, with a common keyway requiring only one key for all switches on campus. The switch key is to be the "2K" model furnished with the above switch.
 3. Keyed switch is to be used to totally shut off power to projectors to allow proper resets to occur as needed with the newer projectors.
 4. Engrave face plate per requirements for all switch devices, note as "**PROJ**" and South, North, East, West, Center.
Example: PROJ-S, PROJ-C, PROJ-N.



27.41.03 CEILING HUNG DATA PROJECTOR:

- a. Ceiling hung or overhead mounted projector systems:
 1. Using Unistrut (when data tech projector weight is over 20 pounds):
 - a) Provide rigid structural support for each ceiling hung projector for the current or future equipment.
 - b) Use 4 Unistrut rails, 2 set perpendicular, 6' long and spaced 3' apart and 2 set parallel to the screen, 4' long for mounting the pipe hanger support to the projector.
 - c) Obtain needed info from **MTSS** for particular projector "pipe" hanger to be used.
 - d) Provide threaded pipe needed between Unistrut mounting plate and tech projector mounting plate. Provide to **MTSS** pipes and lengths required by **MTSS** to properly mount the data tech projectors just below the finished ceiling and in line with the top of the projection screen.
 - e) Isolate from all building and mechanical and system vibrations to prevent image from jumping around screen.
 2. Using the data tech projector mounting kit set on ceiling tile T-bar (when data tech projector weight is 20 pounds or under):
 - a) Kit by Chief, model #CMS-445.
 - b) **MTSS** to specify and install the kit at location identified by **MTSS**. Contractor is to obtain and provide to **MTSS** for installation. **MTSS** is to fasten kit into lay-in ceiling T-bar, with tile beneath the kit, and is to be fastened into place and support at each corner with tie wires capable of supporting 100 pounds of weight on each wire.



- c) Needed pipe length for suspending data tech projector from mounting kit will be furnished, threaded and provided by the project contractor to MTSS to install, if MTSS is not providing the pipe and its installation. MTSS will measure needed length for the pipe and get the needed pipe length to the contractor furnishing the pipe on new or large projects. On small renovation projects, MTSS is to provide the needed pipes.
- b. Coordinate EXACT location with **MTSS**, if **MTSS** is involved with the project - or as specified by the projector manufacturer, based on screen size and projector model.
- c. ROUGH PRELIMINARY PLANNING RULE to aid preliminary conduit placement - the projector is centered about 1-1/2 to 2-1/2 x the (4 x 3 image) screen width from the screen, except when placed in a rear booth, or with special lenses manufactured for a special situations.
- d. **Construction documents must indicate to check with MTSS just prior to installing the projector infrastructure for exact location dictated by the purchased projector model.**
- e. Identify in writing the exact projector model and distance factor prior to placing related components.
- f. Models change so close coordination is necessary with **MTSS** until the actual projector is installed.
- g. Mount screen top & projector as high as possible to maintain the greatest possible distance between projector bottom and floor – in no case less than 9' AFF.

27.41.04 CONVENTIONAL AV POWER / CONDUIT NEEDS:

- a. **Slide or film projector controls** - provide all junction boxes, conduits, wiring.
- b. **Sound jacks** – when requested, provide one sound jack at each box centered as follows:
 1. At front wall near or on the instructional position;
 2. At back of the room;
 3. At a central riser face, if any, about 1/2 way back; similarly connect near the instructional station;
 4. Place these jacks independent of technology podiums in all classrooms, except as directed by **MTSS**.
- c. **At Technology Podiums:** Install one duplex side outlet pedestal (no higher than 3-1/2") on the floor under the podium for the podium power plugs. See detail under section **26.05.05** Conduits between projector and instructional technology podium, page 26.
- d. Engrave all outlet plates in 1/8" high letters for "**SOUND**", "**PROJ-1**", and "**PROJ-2**", etc.
- e. See **27.41.01** above for other power requirements for AV equipment.

27.41.05 TECHNOLOGY OUTLETS / POWER / CONDUIT NEEDS:

- a. **In General:**
 1. Include, place boxes and conduits for fiber and other cabling needed for technology classrooms – see **DIVISION 26.00.00**.
 2. Place such power and cable boxes under/adjacent to the instructional podium, within the student area, if required and above ceilings for instructional tech projectors.
 3. Mount convenience and tech outlets next to all computers and other technology equipment.

4. See other items in this **27.41.00** section for other needs related to instructional technology component needs as well as **26.70.00**.
- b. **Coordination** – work closely on technology outlet, locations and conduit home run needs with **LSLC-O&T**
 1. Generally locate such outlets for network and fiber close to or into the instructional tech podium.
 2. Place convenience outlets close to such “technology” outlet boxes.
 3. Engrave the labels on these outlet cover plates.
 4. Cable-TV access is to be included unless otherwise told.
- c. **For Telecommunications:**
 1. Into or within the room & at corridor benches, involve **LSLC-O&T** & Design Team members.
 2. **Technology Classrooms:**
 - a) Provide minimum (5) high-performance UTP cables and one RG-6 coaxial cable into the instructional technology podium.
 - b) Provide minimum (1) high-performance UTP cable centered in the front wire way or if no wire way centered on the front wall beneath the chalkboard used by the instructor.
 3. **Conventional Classrooms:**
 - a) Provide minimum (5) high-performance UTP cables centered in the wire way or if no wire way centered on the front wall beneath the instructional writing surface.
 - b) Provide minimum (1) RG-6 coaxial cable at the instructional end of the room in the wire way or if no wire way then beside and below the writing surface in the location that best accommodates a cart mounted television.
- d. **At Instructional Tech Podium** – power strips provided by **ITS-TLT** will be plugged into the floor duplex outlet pedestal under the podium.
- e. **At Printer Tables or Counters in Computer Lab-Classrooms** – provide for four-plex outlet above table or counter height.
- f. **At Ceiling Mounted Tech Projectors** – provide 2 duplex outlet at projector location in double gang opening and a single box in single opening for a CAT 6 data line. Also include key lock on/off switch for this projector. Locate key lock next to other controls on wall near instructional tech podium.
- g. **At Corridor Benches:**
 1. Space at 48” o.c. duplex outlet above benches for power use of wireless laptop computers.
 2. Coordinate closely needs with **ITS-TNS** for boxes and conduit runs to these outlet boxes.
- h. **At Flat Panel Information Screens outside Computer Lab / Classrooms:**
 1. Provide blocking in wall to support monitor mounting bracket and the junction boxes for the power, data and security wiring.

27.41.06 INSTRUCTIONAL TECH PODIUM:

- a. PSU design by **ITS-TLT** is to be used, as it is standard on campus. Who provides:
 1. On projects funded by **LSLC** or **ITS-TLT**, podium is generally provided by PSU.
 2. On building projects that are new, major renovations or additions, IT and all technology is fully funded by the project **F F & E Budgets**.
- b. Is to be coordinated with **ITS-TLT** for location, type, and scheduling / delivery needs.
- c. Provide **3'-10" minimum** between podium and the front wall projections (chalkboard rails, chase corners, etc) and **24" minimum** from a sidewall. See plan graphic under paragraph **26.05.05**.

**27.41.07 COMPUTER LAB – CLASSROOM:**

- a. Such rooms have power, network connections and security cabling run in several manners to the technology on the student computer tables. Generally, one to two computer stations are located on a table, depending on table length.
 1. **Table ends or sides butted to walls** – utilities feed from wall mounted multi-channel wire-ways. In such cases, all utilities are to be fed from these wire-ways.
 2. **Free standing tables in rows or groups** – utilities feed from **EACH** floor box serving **EACH** table. Each floor box is to have power outlets, network connections and a place for the security hard wire to rise to fasten to the black box often mounted on the bottom of a table in that row or group.
 3. **Utilities to computer lab tables** are:
 - a) **Network wires** – individual cables to each computer station from the central telecommunications room – necessary in floor boxes or at the wire-ways.
 - b) **Security fiber optics** – this is looped through a series of computer stations, usually in a row or group of tables that ties to a “black box” mounted to a table and hardwired back to the telecommunications room via the wire-way or the floor boxes (usually at only one floor box per group or row).
 - c) **Power:**
 - 1) **Via floor boxes** – each computer station needs two plug outlets for power or junction boxes for pigtailed or whips.
 - 2) **Via wall mounted wire ways** – two possibilities exist, depending on furniture supplier:
 - (a) **Twist lock connectors** - female power connectors are desired at the wire-ways used to feed power to each of the table rows or groups of tables. A twist lock male plug is to be mounted to a 4' cord of a 6 plug power strip.

- (b) **Pigtails or whips** - for wiring into wire ways or junction boxes.
 - 3) Some furniture suppliers use pigtails or power whips that require wiring into independent power circuits. Provide junction boxes and space needed for the minimum number of power circuits (often 4 independent circuits) used by such furniture systems.
 - d) **Tables** – are to be provided with under-table continuous enclosed and covered wire management enclosures fabricated with removable covers that secure firmly and positively into place.
- b. **Instructional technology podiums** are to be installed in these rooms as noted previously and hereafter.
- c. **Printer tables and stations** are to be included in each computer lab–classroom with capability for at least two printers (double duplex outlet and 4 data jacks).
- d. **Who does what:**
1. **The Contractor:**
 - a) **For Network wires** – pathways, conduits, labeled pull-strings, wire-ways are to be provided from the telecommunications rooms to each station via the wall mounted wire-ways or floor boxes with appropriate termination components for the boxes.
 - b) **For Security** – pathways, conduits, labeled pull-strings, wire-ways from telecommunications room to “black boxes” at each row or group of tables, whether at wall or at floor box. Exception: security contractor is sub to the contract work, then wire is pulled and terminated at each end – (1) the telecommunications closet at one end and the black box at the wall wire-ways, and/or (2) the telecommunications room at one end and the black boxes to be fastened to each group or row of free standing tables with continuous wires via the floor boxes.
 - c) **For Power** – wire-ways, conduits, wires from electrical panels (1) to the twist-locks and the wiring of the mating twist lock to the power strip for feeds from wall mounted wire ways; (2) to floor boxes (no plastic parts exposed to wearing floor surfaces or sliding tables), with the 4-plex outlets in each floor box, and (3) to pigtails or whips to be fastened at the junction boxes to the necessary number of circuits.
 2. **PSU:**
 - (a) **Network wires or cables** between device boxes in classroom and furniture are pulled and terminated by PSU unless noted otherwise.
 - (b) **Security** – wiring and black boxes furnished and installed unless part of contracted work with contractor.
 - (c) **Power** – daisy chaining power strips from the twist lock unit, the convenience outlets, the pigtails or whips for the power to the other tables butting against walls; plugging power into floor boxes for technology on free standing rows or groups of tables.
- e. **Floor box locations:**
1. No less than one for every two computer stations (with room for double duplex outlet, 4 data cables and security cables).
 2. Locate toward the front edge of the tables and close to a leg.
 3. Do not place in aisles or in seating areas where rolling chairs can damage connectors or wires.

4. **Furniture products and plan layouts require identification early in design to allow proper definition and location of floor boxes.**

f. **Wire-way locations:**

1. Tops just below tables where table ends butt against walls.
2. Bottoms just above tables where table backs butt against walls.

27.41.08 AMX, CRESTRON OR OTHER SPECIAL MEDIA & TECHNOLOGY CONTROL SYSTEMS:

- a. Used most likely in large spaces requiring many technology components.
- b. Subcontracted, usually, to AV integrators who write intensive software programs that permit the control system to properly and functionally operate the various devices (sometimes room lights, most often DVDs, VCRs, computers, data projectors, sound systems, document cameras, laptop computers, other plug-in devices, etc).
- c. Involve intensive software programs most often with compiled and un-compiled data or source code.
- d. Provide to PSU such compiled and un-compiled data or source codes in written and electronic form via the subcontracted AV integrator, with the complete code system turned over to **PSU** and **MTSS** upon complete and functional installation of the system - to allow maintenance and modifications by **PSU** when system components are changed or added thereafter.
 1. **Code** - Provide the actual and complete operational code to **PSU**.
 2. **License PSU for Code and Components** - The developer/vendor shall allow **PSU** to have ALL components of the software, in essence licensing the complete code in perpetuity to **PSU**, thus allowing **PSU** to use the code to modify the system and become the exclusive Owner of the software code for the unique location to which the code is developed.
 3. **Warranty** - The developer/vendor shall fully warrant the Audio/Visual System furnished to be free from defects in workmanship or failure for a period of one (1) year from the date of acceptance or first beneficial use, whichever occurs first. Warranty service for such defects will be handled in a reasonable and timely manner from the time of notification to winning bidder by the Owner or their agent. Warranty covers on-site service for equipment, installation materials, installation labor and control system programming. The developer/vendor shall also document and include in the final electronic format any code changes during the one (1) year warranty period after the FULLY functional code and system is accepted by PSU. The developer/vendor shall be responsible for all required diagnosis, labors, costs, repairs, code and documentation updates during that time.
 4. **Use-testing** - Once system and code is considered FULLY functional, it shall be used for a period of at least 10 days to be proven error free and perform accurately. No Trojans or codes are to be built into the software that create problems tied to dates or times. If the operating code is not error free and if not performing accurately in this 10-days, the developer/vendor will be required to make the proper code and function changes, at which point the 10-day error free period will once again commence. This cycle shall continue at the cost of the vendor until all systems and codes operate properly and without error for the particular installation. The one-year warranty period for the software starts upon evidence that the code is correctly written and properly operating the technology. This warranty is NOT tied to the building or hardware substantial completion date. The system and code is to be noted in writing as accepted by MTSS and ITS-TLT representatives.
 5. **Documentation** - The detailed documentation of all code shall be provided to **PSU** in the care of **MTSS** by paper copy as well as in electronic form on CD in the latest version of Microsoft Word.

6. **Equipment specifications and cut sheets** – to be provided to PSU ITS-TLT representatives at time of installation and information to include manufacturer address, phone number, email, website and very specific information about each item that allows easy replacement if components fail after the warranty period expires.
- e. **USE NO BNC CABLES – ONLY CABLES WITH ENDS SPECIFIED BY MTSS – thus the need for 2” electrical metal conduits (no substitute sizes or plastic allowed) defined in Sections 26.05.05 and 27.41.02 in this document.**

27.41.09 HEAD END (BUILDING TECHNOLOGY CONTROL) ROOMS (HER):

- a. Audio visual systems installed in GPCs to be stand alone systems for each GPC or GPC auditorium.
- b. Separate such GPC and HER rooms and equipment so that HER components are not affiliated with operations of the GPC's instructional technology components.
- c. Some interconnection may occur:
 1. Of the GPC instructional technology equipment to the HER components to allow data and audio to be received from or transmitted into the GPC from the HER.
 2. To allow information to be routed to other rooms from or into the GPCs.
 3. **To not route** GPC technology functions through such HER equipment for operation of the GPC tech functions, though. GPCs to stand independently.
- d. Reasoning:
 1. Equipment, software and routing equipment and systems in HERs greatly complicate the operational functions of the individual GPCs.
 2. These HER components greatly affect the ability to upgrade / replace GPC technology required for class instructional needs and continual updates.
 3. Such HERs house highly sophisticated systems that create additional maintenance and repair issues which in turn delay or prevent timely resolution of operational problems related to GPC audio visual systems.
 4. The HERs are the responsibility of the department/college to maintain and upgrade, including the interface components allowing the tie to the GPC technology.

DIVISION 28.00.00 ELECTRONIC SAFETY AND SECURITY:

28.00.00 GENERAL:

- a. All security components to be fully functional prior to use of classrooms for instructional purposes.
- b. Costing of work:
 1. On projects funded by **LSLC** or **ITS-TLT**, security cost is generally by these **PSU** entities.
 2. On building projects that are new, major renovations or additions, the project **F F & E Budgets** cover the costs.

28.01.01 SECURITY LINES:

- a. Provide wiring pathway from main telecommunications room to podium, projector and any permanently located classroom computer equipment.
- b. Where conduit is required, a minimum diameter of one (1) inch is required for the podium, the projector and the common raceway for permanently located classroom computer equipment.
- c. Close coordination with **Police Services** and their vendor is essential since they will be taking care of system.
- d. Refer to section **28.40.00** for more detail related to GPC and GPC-Computer Lab security information.

28.01.02 REFERENCES:

- a. PSU – Department of University Safety – Security Access Controls Specifications, and related documents, are to be obtained as follows:

Contact Eric Bauman at 814-865-7186 or at egb117@psu.edu for PDF files covering the below topics.

1. Access Controls Document
2. Alarm System Specification
3. CCTV Security Systems Specification

- b. **Commissioning at classrooms** – refer to section 40.80.00.

28.10.00 BUILDING SECURITY (DOORS):

Generally not applicable to general-purpose classrooms as they remain unlocked from 7 am to 11 pm, Monday through Friday, during each semester, unless technology maintenance requires a lock-down. Rooms may be locked between semesters and during semester breaks after janitorial staff has cleaned rooms.

28.20.00 CORRIDOR SECURITY CAMERAS:

- a. Required at corridors serving GPCs and GPC-Computer Labs. Exceptions to this requirement are to be documented in writing to the designers by the LSLC-O&T subcommittee.
- b. Comply with other notations under this **DIVISION 28.00.00** heading relative to meetings, detailing construction documents, defining points, working with Police Services, running pathways from the cameras to the telecommunication rooms, installation, testing wires, providing power sources where needed, etc.

28.40.00 CLASSROOM TECHNOLOGY EQUIPMENT SECURITY (COMPUTERS, TECH PROJECTORS, PRINTERS, PLOTTERS, MONITORS, SCANNERS, ETC.):**28.41.00 General:**

- a. All GPC and GPC-Computer Lab technology equipment is to be protected with a theft security system that will report to University Police.

- b. Consulting Design Team is to work early with the **LSLC-O&T** for general equipment requirements that may
 - 1. help establish termination points for such security equipment and
 - 2. set the project security design parameters for the GPC-Computer Labs.
- c. Consulting Design Team is to continue coordinating details with the **LSLC-O&T** representatives and major users of the rooms during project design and at each subsequent design refinement meeting:
 - 1. to further define the required details in the developing construction documents;
 - 2. to further refine information about the intended technology for each GPC and GPC - Computer Lab;
 - 3. to produce single line schematic diagrams reflecting all connection points and equipment and terminations at components at other end;
 - 4. to consequently produce specifications for contracting method, vendor prequalification and partnering, system testing and signoff that impact substantial completion for the project.
- d. Security specifications for each classroom project shall be provided by Eric Bauman, Security Systems Administrator. Locations of security panels shall be shown on drawings (See 28.01.02 – a.).

28.42.01 GPC and GPC - Computer Labs -- Contract Documents must define the following:

- a. Wiring pathways from the main telecommunications rooms to the points in the classrooms (examples are: podium technology, ceiling tech projectors, document cameras, student computer stations, etc.)
- b. Locations for pathways (such as conduits) where easy access cannot be obtained (as example – above drywall ceilings) to run low voltage security wiring.
- c. Sizes of conduits for such pathways from each classroom to the main telecommunications rooms.
- d. Specific security layout for the system that will be developed in conjunction with the University Police representatives to the **LSLC-O&T**, based on defined furniture plans for each GPC – GPC Computer Lab.
- e. Termination points for each end of each security device necessary for properly monitoring all GPC and GPC - Computer Lab technology equipment.
- f. Wiring for the security systems from the termination points in each of the GPC and GPC - Computer Lab rooms.
- g. Duplex outlets for powering security equipment at positions needed for the security equipment components to function properly.

28.42.02 Termination devices to be noted and locations defined for each particular GPC and GPC:

Computer Lab room applications (black box for fiber optic loops through student equipment and at instructional tech podiums, resistors at ceiling hung tech projectors, the main security panel in the telecommunications rooms, etc.).

28.42.03 Who provides and does what:

- a. Wiring and conduit to be run and placed as a part of the construction contract work as defined in the construction documents - done in close coordination with the selected security vendor that will be doing the installation;

- b. Such individual sets of wiring to have each end labeled with unique identifier particular to each set of wires running from the classroom termination point into the telecommunications room.
 - 1. Testing of the wires to be done by installing electrical (sub)-contractor in presence of security personnel and vendor (sub)-contractor to assure that all wires properly terminate as labeled.
 - 2. Any wiring not testing correctly to be replaced by electrical installer and tested until it is passed and accepted by the security personnel and vendor (sub)-contractor.
 - 3. After successful testing of the installed wiring, and acceptance by the security vendor (sub)-contractor, the security vendor (sub)-contractor will be responsible for the wire and its terminations.
- c. Security main control panels, keypads, black boxes (fiber-optic security devices), etc. to be provided and installed by the security vendor (sub)-contractor and wired together via the wires provided in the general or electrical (sub)-contract work;
- d. Fiber optic cables will be furnished and installed by **PSU** ITS-TLT and MTSS technicians, who are to run the fiber-optic cables through the tech equipment and make connections to the black boxes as well as connect the wires to the tech projector resistors.

DIVISION 40.80.00 COMMISSIONING:

40.80.00 GENERAL:

- 40.80.01** To include review and coordination of all trades relative to the general purpose classrooms and other classrooms that could be rolled-over to GPCs.
- 40.80.02** To apply to new and major renovation projects and minor projects costing greater than a million dollars.
- 40.80.03** To include the GPC facilities coordinator as well as other members of the LSLC-O&T at all phases of the project.
- 40.80.04** To include the LSLC-O&T in a punch list walk-thru and subsequent punch list follow-ups.
- 40.80.05** To require the contractor to provide interference drawings that reflect components at the ceilings, walls and floors around each classroom, including the interstitial space between the structural elements and the finished spaces.
- 40.80.06** To define gains/losses through value engineered components affecting classroom needs as required in this document.
- 40.80.07** To compare to original building space program and to identify compliance and deviations.

40.81.00 ARCHITECTURAL:

- 40.81.01** To include all elements that could be subject to installations, interferences or applications related to plumbing, sprinkling systems, HVAC components, electrical, lighting and telecommunication conduits or raceways.
- 40.81.02** To include all elements that relate to sound attenuation and need to maintain low decibel levels from building systems and components.

- 40.81.03** To apply to any and all elements that could introduce vibrations into any part of the building components passing over or by general purpose classrooms.
- 40.81.04** To cross coordinate with all other design team members in all the building aspects:
- a. To minimize conflicts at classrooms from all other building elements.
 - b. To identify to the project team any and all building aspects proposed and designed by any consultants to the architectural design firm involved with the project.

40.82.0 STRUCTURAL:

- 40.82.01** To work with all the design groups to be sure that structure can be isolated from vibration inducing elements so that structure does not transmit such vibrations into the classroom technology equipment and space.
- 40.82.02** To work with all design groups to maximize the clear ceiling heights in the classrooms.

40.83.00 PLUMBING, SPRINKLING SYSTEMS & HVAC:

- 40.83.01** To not interfere with needed high ceiling spaces at all classrooms due to educational technology needs to keep data projectors and screens tight to structural components.
- 40.83.02** To isolate vibrating ducts, building machinery, piping, etc. so as to not introduce vibrations into the structural and finish systems.
- 40.83.03** To do proper testing and balancing for heating and cooling for the occupant loads, latent heat gains, educational technology used in each classroom, solar and/or other loads incurrent in each classroom.
- 40.83.04** To do tests to be sure that diffuser air is not causing movement to projection screens or creating uncomfortable noise and distraction to classroom occupants.

40.84.00 ELECTRICAL, LIGHTING & TELECOMMUNICATIONS:

- 40.84.01** To be sure that lighting zones are properly conceived and implemented, along with the necessary switching systems in the appropriate locations.
- 40.84.02** To verify that power systems are appropriately circuited and grounded as noted herein to prevent contamination of the instructional technology components.
- 40.84.03** To verify that the appropriate pathways exist for telecommunication systems and data systems between components in each classroom and the centralized distribution points.

40.85.0 ELECTRONIC SAFETY AND SECURITY:

- 40.85.01** To test for continuity of wiring and fiber between classroom components and the security monitoring box that alarms back to police services.
- 40.85.02** To be sure that all security components related to the classrooms are fully functional before releasing any vendors from the project.

END